



# WIRE DESIGN SYSTEM 2022

[WWW.BLUEWAVE.DK](http://WWW.BLUEWAVE.DK)

  
**BLUE WAVE**<sup>®</sup>  
WIRE DESIGN SYSTEM

### **Information and contact**

You are kindly asked to contact your local Blue Wave dealer/distributor, or Blue Wave direct, should you have questions or need further documentation.

---

#### **Blue Wave A/S**

H.C. Oerstedsvej 2  
DK 6100 Haderslev  
Denmark

#### **Email:**

bluewave@bluewave.dk

#### **Website:**

bluewave.dk

#### **Phone:**

+ 45 73 22 14 14

#### **Coverpage photo:**

MOON SOON

## **BLUE WAVE RIGGING HARDWARE**

Blue Wave was founded in 1932 and has since been supplying and developing stainless steel fittings and turnbuckles for marine, architecture, industrial and safety applications.

Our goal is to become first choice when ever it comes to stainless steel rigging hardware!!! Based in Denmark we pride ourselves of supplying a Scandinavian design and high consistent quality fittings.

We are ISO 9001:2015 certified – and for some ranges also carry EU design registration while our range of swageless terminals with jaws are Lloyds certified.

Over the years we have been awarded for our work and cooperate with some of the world leading companies and institutions.

World wide; good and longtime partnerships have helped Blue Wave grow into one of the world largest suppliers of stainless steel fittings and tensioners for wire, rod and fiberropes.



# TABLE OF CONTENTS

WIRE DESIGN SYSTEM

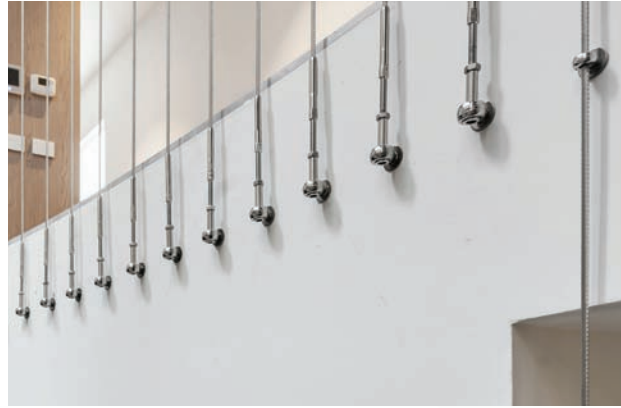

## 2-5

Blue Wave Rigging Hardware

## 6-17

Facts & Information

## 10 & 11

Wire Railings

## 12

Certificates

## 14-17

Assembly Instructions

## 18-27

Fork Rigging Screws & Fork Terminals

## 28

Adjuster Fork & Tiebar System

## 29-30

Toggle Rigging Screws & Toggle Terminals

## 30-33

Eye Rigging Screws & Eye Terminals

## 34-36

Terminal Rigging Screws & Thread Terminals

## 37, 46

Swageless Rigging Screws & Swageless Terminals

## 38-42

Threaded Parts

## 43

Rigging Screw Bodies

## 44-45

Inside Thread Parts

## 46

Swageless Terminals - Small

## 47-48

Terminals

## 49

Angle Hinge

## 50

Balls

## 51-52

Wire Clips & Clamps





**53**

Wire Reliefs & Cover Discs

---

**54**

Stoppers

---

**55**

Wood Threads

---

**56-57**

Glass Roof Fittings

---

**58-59**

Shade System - Membrane Plates

---

**60-61**

Wire Railing - Ball Connection

---

**62-63**

Trellis Post - Green Line System

---

**65**

Ballustrade Kit - Vertical Wire

---

**66**

Eyebolts

---

**67**

U-bolts

---

**68**

Straps

---

**69**

Schakles

---

**70**

Thimbles

---

**71**

Nuts

---

**72**

Pins

---

**73**

Splits & G-Rings

---

**73**

Wire Ropes

---

**74-75**

WDS Tools

---



# FACTS AND INFORMATION

## Working with wire fittings

When planning a wire construction the ultimate break load, as well as the work load, must be calculated as it will determine the minimum wire size and maybe the wire construction needed.

Blue Wave's fittings, unless otherwise stated, are constructed after termination to meet 90% of the break load on wire ropes that are standard on the market. To reach full break load jaw terminals must carry/be filled to 80 % of jaw width.

**Please note:** In order to guarantee safety in a wire construction you should calculate a safety factor of 2-3 on static constructions and a minimum of 5 on dynamic constructions. As a general rule working loads should never exceed 20% of the break loads stated in this catalogue.

For further details ask your Blue Wave wire design system distributor or contact Blue Wave A/S directly.

## SWAGE DIMENSIONS CHART

Wire mm	Thread Metr.	Inside Diameter (+/- 0,2)	Outside Diameter (+/- 0,10)	Depth (+/- 1,5)	After Swaging mm
2,0	M5	2,2	5,5	32	4,7 - 4,82
2,5	M5	2,8	5,5	32	4,7 - 4,82
3,0	M6	3,5	6,35	38	5,44 - 5,56
4,0	M8	4,4	7,5	45	6,23 - 6,35
5,0	M10	5,3	9,0	51	7,83 - 7,95
6,0	M12	6,5	12,58	64	10,95 - 11,12
7,0	M14	7,5	14,2	70	12,5 - 12,7
8,0	M16	8,4	16,0	83	14,07 - 14,3
10,0	M20	10,5	17,8	89	15,7 - 15,9
12,0	M20	12,5	20,0	105	17,6 - 17,8
14,0	M22	14,8	25,0	140	22,0 - 22,23
16,0	M24	17,0	28,0	160	25,15 - 25,40
19,0	M27	20,0	34,5	200	31,44 - 31,75
22,0	M30	23,5	40,5	230	36,2 - 36,50
26,0	M36	27,5	46,0	280	40,97 - 41,28
28,0	M48	30,0	50,0	300	44,00 - 44,50
30,0	M52	31,5	58,0	315	51,00 - 51,50
32,0	M56	33,5	58,0	340	51,00 - 51,50
36,0	M60	38,0	65,0	380	57,00 - 57,80

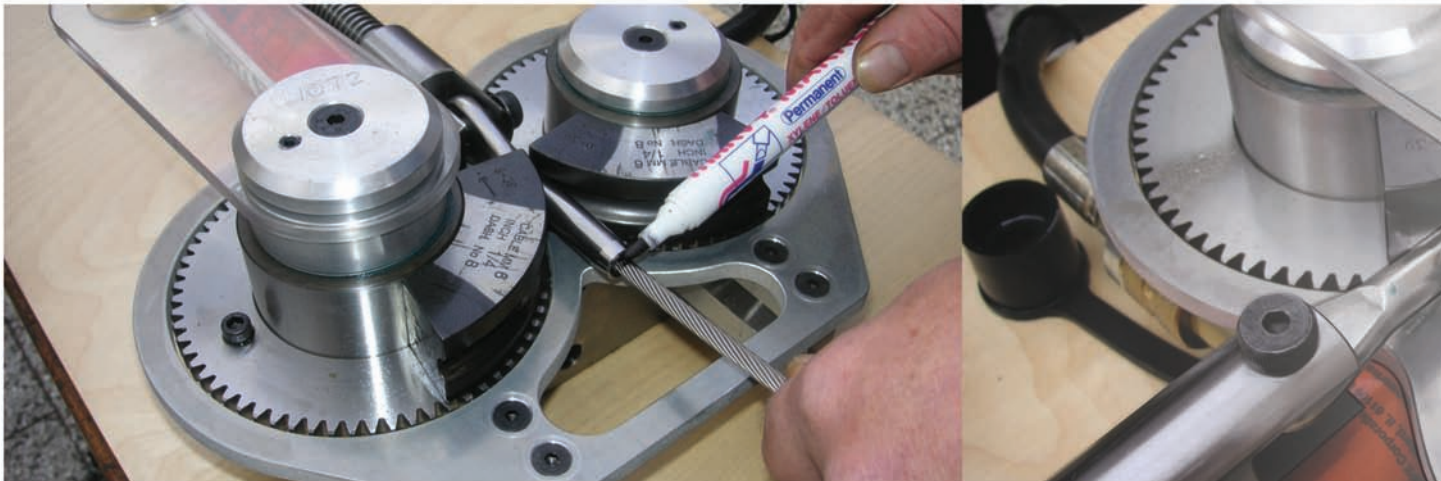

## CORRECT ATTACHMENT

Ensure that the wire is clean and has an evenly cut end.

Always use the correct size standard dies recommended by the supplier. Correct wire attachment/termination can only be achieved by firmly swaging the material of the terminal into the strands of the wire.



Most Blue Wave terminals are marked with wire size and a mark indicating the hole depth and where to start for correct swaging.

Blue Wave wire terminals correspond to the standard sizes and stainless materials used in the market. The terminals are produced so that a swage machine (e.g. from Wiretechnik) will produce a swage within given tolerances in 1 (one) pass in the machine. When extremely compact strand ropes are used, 2 (two) passes in the same track could be needed to reach tolerances.

### Additional passes should NOT be made.

Where wire hole depth is not marked e.g. on the small terminals, the wire hole depth must be measured before swaging, not only to find the point to start the swaging, but also to get the right length of the final wire including the fittings.

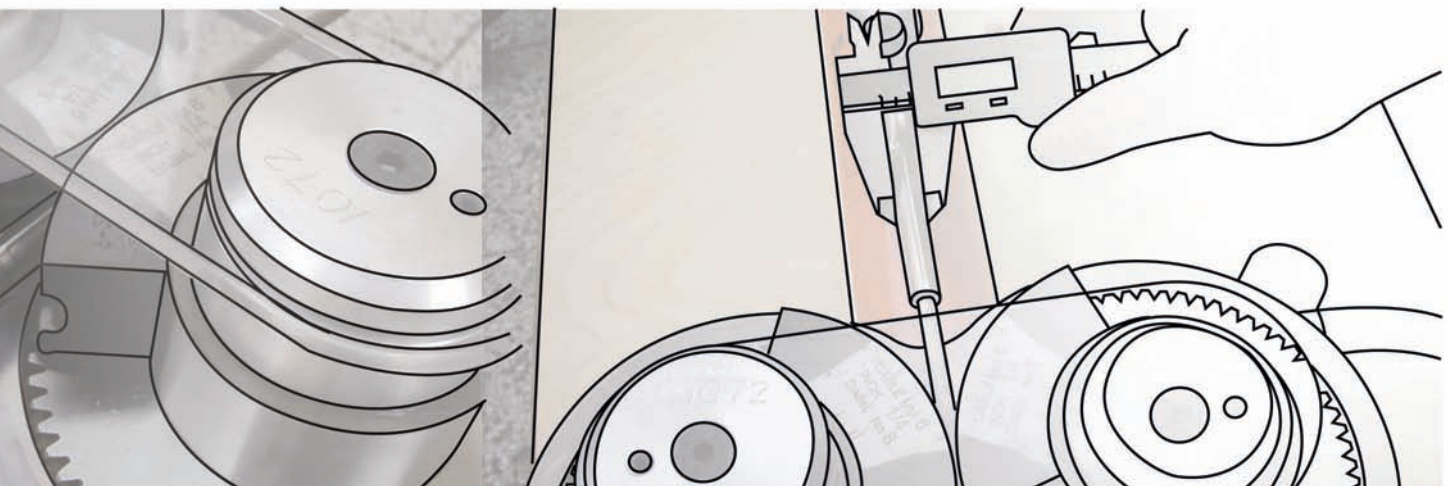

**Caution:** By swaging the terminals onto the wire, the shaft will get a little longer.



## ATTACHING TERMINALS

Throughout the WDS catalogue you will find indications of the correct attachment.



For full break load Blue Wave recommends pressing  or swaging/rolling  the terminals onto the wire ropes. Recommended machines for this purpose are e.g. pPresses from TALURIT® and roller swaging machines from WIRETEKNIK. The terminals are also suitable for rotary hammer pressing.

## SWAGELESS TERMINALS

If the exact length of the final wire is unknown a good solution is only to swage one end and screw  a swageless terminal onto the wire for final attachment on site at the other end (see instructions on page 14+15).

## SMALL TERMINALS

Alternatively the WDS range of small fittings can be crimped  onto the wires by using a hand tool, however, due to reduced amount of material in the small fittings, only a 50% break load of the wire can be obtained by this method.

## ELONGATION AND STRETCH IN WIRE ROPE

Two different kinds of elongation can be distinguished. Constructional elongation and material elongation which is specific to the material used in the manufacturing process.

### Structural elongation

After the manufacturing process of the ropes and strands, small gaps remain between each wire within the strand and between each strand in the rope. When the rope is tensioned, the wires and the strand move closer to each other, and reach their optimum position. A result of the process is that the rope permanently elongates to a certain extent.

This constructional elongation is not the same in every rope construction. It depends on lay, lay length, rope construction and other factors.

### Material elongation/Elastic

This elongation concerns the material that the single wires are made of. It occurs when the wire is tensioned. The material elongation is proportional to the applied load. Under normal circumstances the rope will almost regain its original length. If forces however exceeds 50% of the break load of the material, then plastic deformation occurs and the lifetime will be affected immediately. Therefore proofload tests at max 2/5 of the break load.

The material elongation can be calculated with the following formula:

$$ES \text{ (elastic stretch)} = \frac{\text{Applied load (kN)} \times \text{wire length in mm}}{E\text{-Modulus (kN/mm}^2) \times \text{Cross sectional area (diameter}^2 \times \text{Pi/4)}}$$

## WDS BREAK LOADS

Wire	Thread	Break Load
mm	Metr.	Kg
2,0	M5	800
2,5	M5	800
3,0	M6	1.200
4,0	M8	1.700
5,0	M10	2.500
6,0	M12	5.100
7,0	M14	6.800
8,0	M16	8.700
10,0	M20	9.700
12,0	M20	11.400
14,0	M22	14.700
16,0	M24	18.000
19,0	M27	23.000
22,0	M30	28.000
26,0	M36	41.000
28,0	M48	70.000
30,0	M52	80.000
32,0	M56	90.000
36,0	M60	115.000



## TENSIONING OF WIRE WITH TERMINALS

As well as serving as an attachment to a given construction, threaded terminals, once on the wire, can serve as a tensioner. Where tension cannot be applied to the thread via a nut at the end, the wire can be tensioned by use of e.g. right handed and left handed thread terminals at each end of the wire, by turning the whole wire it will be tensioned.

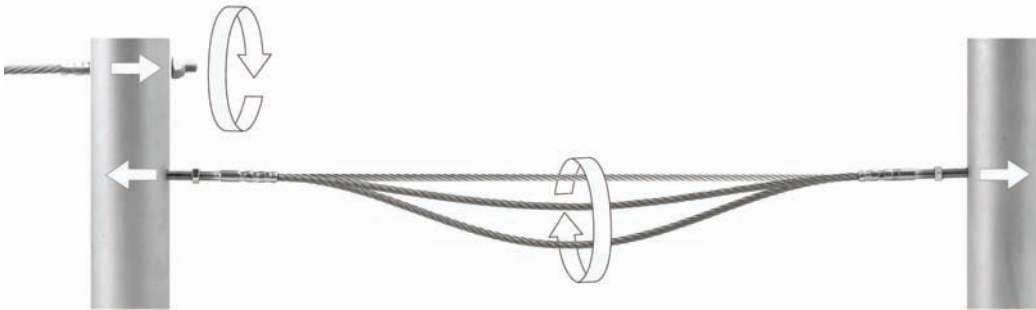

## RECOMMENDED MAX. LENGTH

### BLUE WAVE FITTINGS

WIRE Ø	G	L + L	RML - 7 x 19	RML - 7 x 7	RML - 1 x 19
3	M6	62	10M	12M	14M
4	M8	76	12M	13M	15M
5	M10	84	14M	14M	16M
6	M12	106	16M	16M	19M
8	M16	132	16M	19M	20M
10	M20	160	16M	20M	22M

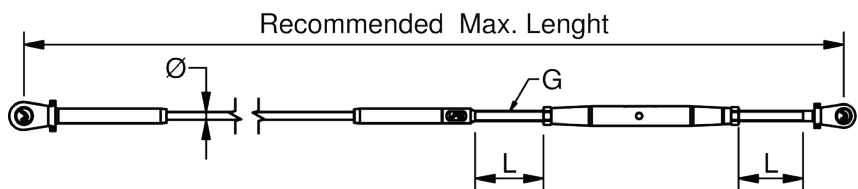

### BLUE WAVE SMALL FITTINGS

WIRE Ø	G	L + L	RML - 7 x 19	RML - 7 x 7	RML - 1 x 19
3	M5	36	6m	10m	12m
4	M6	44	8m	10m	14m
5	M6	44	10m	12m	14m
6	M8	46	10m	12m	14m

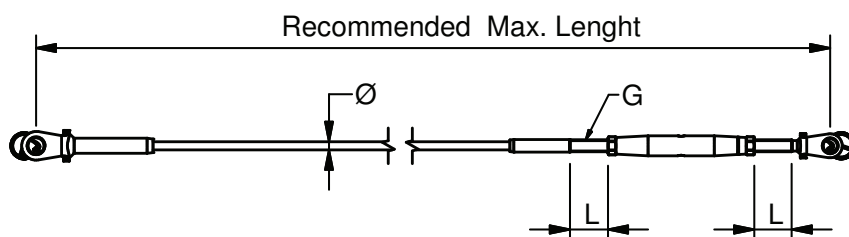

# WIRE RAILINGS

The flexibility of the wire design system offers a solution to almost every imaginable wire railing possible.

Below a selection of wire attachments and tension options have been set up for inspiration. Find details inside the catalogue and contact your local wire design dealer for further advice.

## STRAIGHT ATTACHMENT

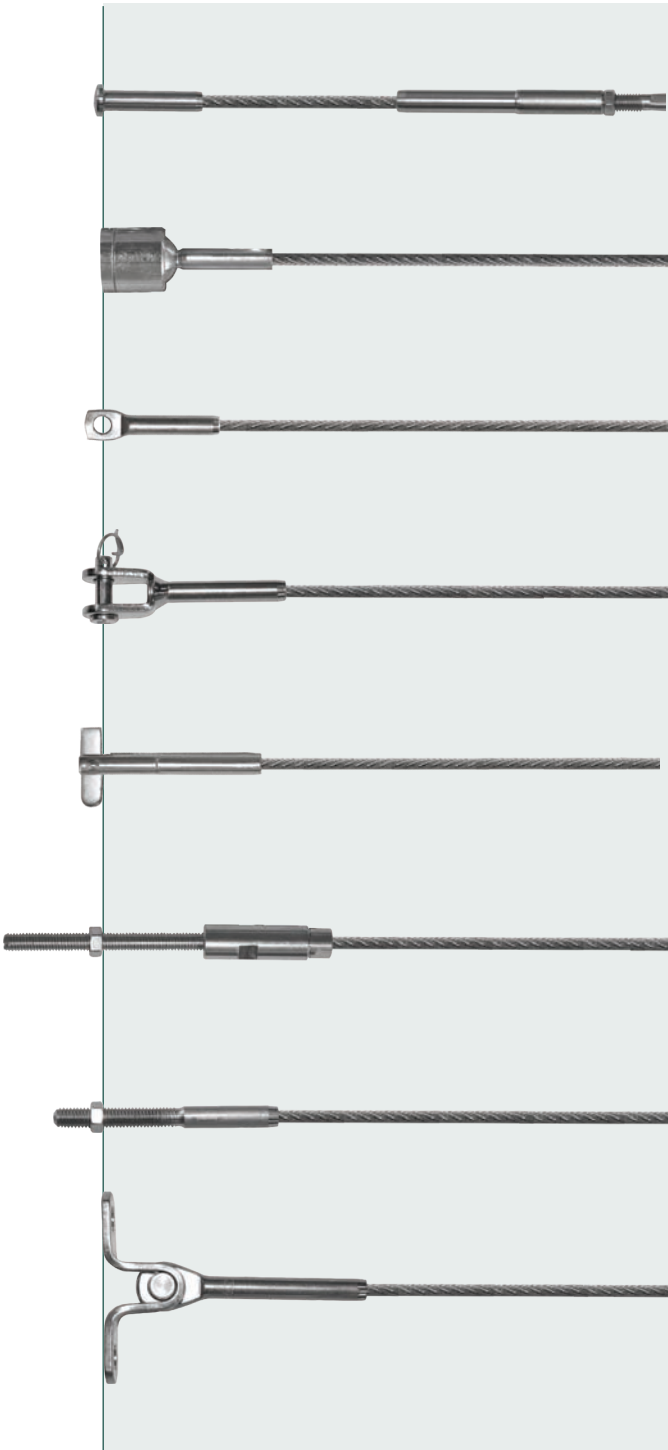

## DIAGONAL ATTACHMENT

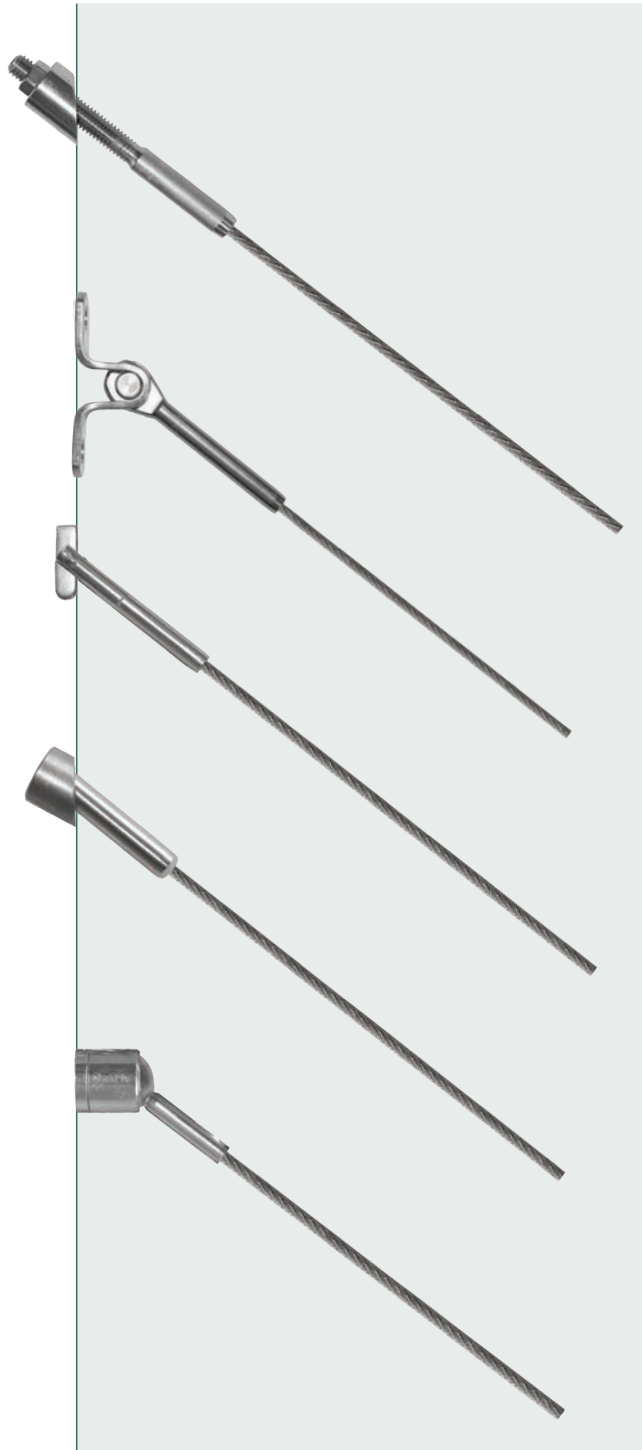

## TENSION AND ATTACHMENT

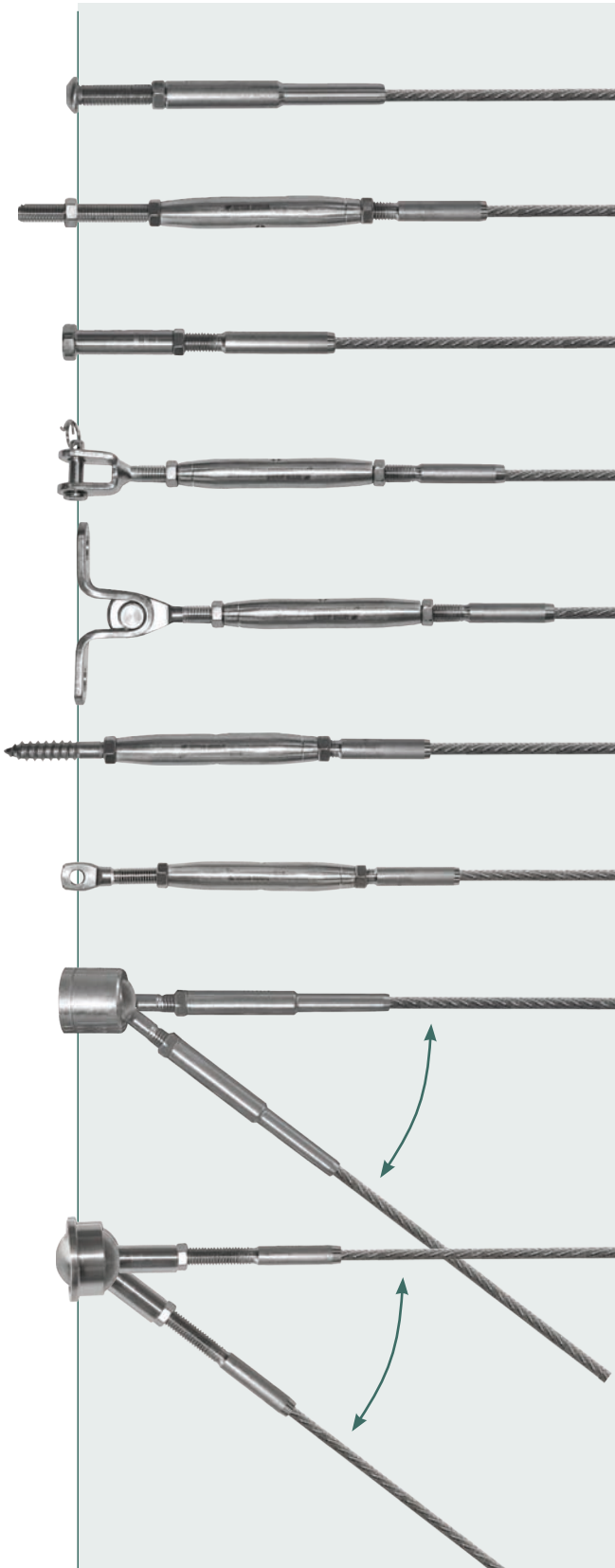

## TENSION AND CONNECT



## WIRE RELIEF



# STAINLESS STEEL GRADES AND CERTIFICATES

Below is a table of the most frequently used types of stainless steel grades and their chemical composition.

EN	AISI	C %	Cr %	Ni %	Mo %	N %	Si <%	Mn <%	S <%	P <%	PREN
1.4301	304	≤ 0,07	17,5 - 19,5	8,00 - 10,5	-	-	1,0	2,0	0,015	0,045	17,5
1.4401	316	≤ 0,07	16,5 - 18,5	10,0 - 13,0	2,00 - 2,50	-	1,0	2,0	0,015	0,045	23,1
1.4404	316 L	≤ 0,03	16,5 - 18,5	10,0 - 13,0	2,00 - 2,50	-	1,0	2,0	0,015	0,045	23,1
1.4571	316 Ti	≤ 0,08	16,5 - 18,5	10,5 - 13,5	2,00 - 2,50	-	1,0	2,0	0,015	0,045	23,1
1.4462	318 LN	≤ 0,03	21,0 - 23,0	4,50 - 6,50	2,50 - 3,50	0,1 - 0,22	1,0	2,0	0,015	0,035	30,9

Blue Wave uses a X-ray device for the control of raw materials.

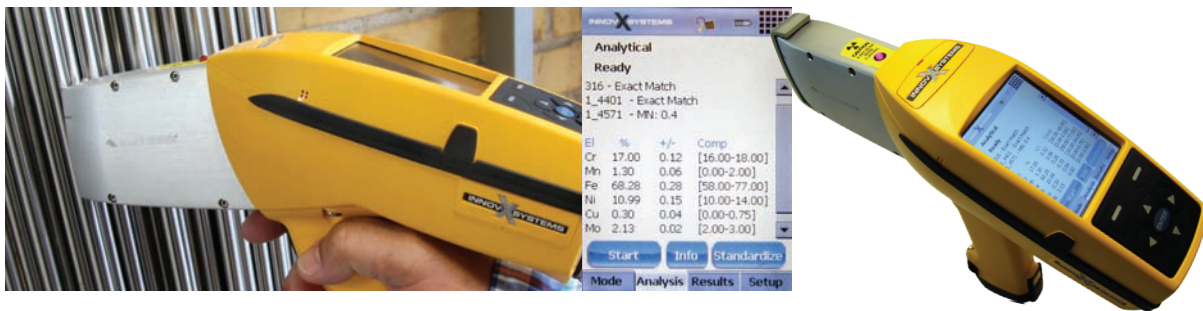

## ISO CERTIFIED PRODUCTION

We are ISO 9001:2015 certified and do on request issue the following certificates for our products.



## CERTIFICATES

CERTIFICATES	DESCRIPTION
BWCC	Certificate of conformance
BW21	2.1 Certificate; declaration of compliance with the order
BW22	2.2 Test report, non specific
BW31	3.1 Inspection Certificate, specific w. destructive test

# HOW TO KEEP THE STAINLESS STEEL STAINLESS



**Claus Qvist Jessen**  
MSc, chem. Eng, PhD  
Damstahl a/s



Stainless steel is a wonderful material, and treated properly, it will stay bright and stainless forever. Sadly, natural saltwater is one of the most aggressive and corrosive media towards stainless steel, and even the "acid resistant" 316L class requires a bit of maintenance in order to stay stainless.

In case of 316L above water, the main issue is time. Saltwater is very aggressive towards virtually any alloy, and the key issue is to keep the contact time as short as possible. In wet, temperate conditions, such as Scandinavia, the Canadian West Coast or the South Island of New Zealand, the all-too-common rain takes care of this, however, in warmer and drier conditions, such as Southern Europe and The Middle East, things are much different. Here, all saltwater sprayed onto the steel will tend to stick to the steel forever, with little chance of rain from above. Similar conditions are observed in dry season in the Caribbean, the tropical Pacific, or in South-East Asia. In the wet season, these places receive large amounts of rain, rendering any freshwater cleaning superfluous.

Very likely, the saltwater will cause superficial pitting corrosion, and although such attacks may not cause operational failure, it certainly looks unattractive and should be avoided. The best and cheapest way to avoid pitting corrosion is to keep the contact time low. Cleaning off the saltwater as quickly as possible keeps the contact time short, and the risk of corrosion correspondingly low. **The more frequent the freshwater rinse, the better**, and, presumably, a thorough rinse every fortnight should do the trick.

Be particularly aware that fittings below a braided steel cable are particularly prone to collecting saltwater, and so is the braided cable itself. Due to gravity, the upper fittings (pointing downwards) are less exposed to saltwater and may be rinsed less frequently.

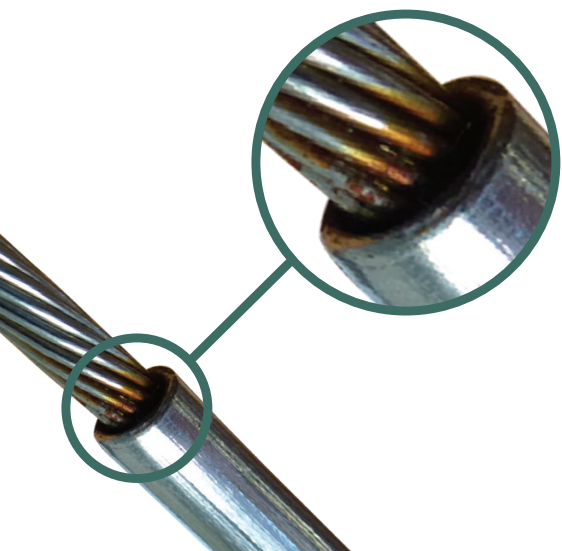

# SWAGELESS JAW TERMINALS



Jaw housing



Jaw housing



Pressure ring (brass)

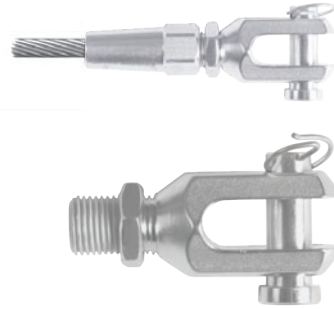

Head

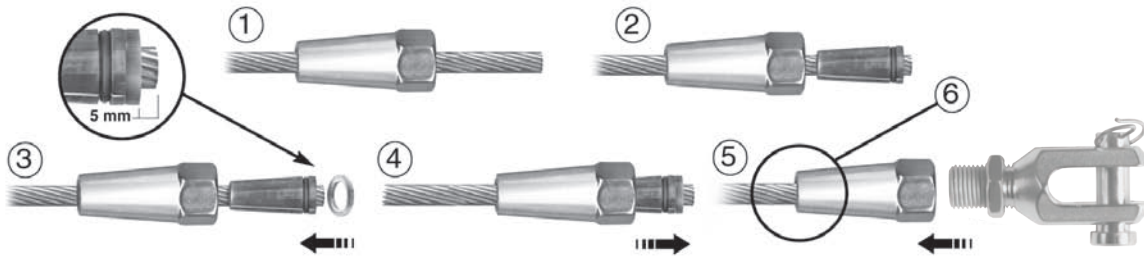

## ASSEMBLY INSTRUCTIONS

- 1:** First slide the jaw housing in place on the cable.
- 2:** Then slide the jaws onto the cable, ensuring there is some space between the jaw section.
- 3:** Place the brass pressure ring on the end of the cable. Make sure that the distance from the pressure ring to the end of the cable is 5 mm.
- 4:** Slide the jaw housing over the jaws.
- 5:** The terminal can now be assembled. Screw the head firmly on the jaw housing with a spanner. Then tighten the lock nut firmly with a spanner.
- 6:** **The terminal must be sealed with a non-acidic sealing compound when assembling, Sikaflex-221, for example.**  
Disassemble the terminal and fill the jaw housing and the cavity with sealing compound, then assemble the terminal. Repeat this until the sealing compound emerges from the hole through which the cable is inserted. Clean the terminal. Do not reuse the jaws. Make sure that the dimensions of the terminal and cable match.



## Maintenance

Check the terminal regularly for damage in connection with longer exposure to concentrated saline solutions or polluted surroundings. Check the seal, if it is broken remove all sealing compound. Then rinse the terminal with fresh water and treat it with WD40. Reseal the terminal with non-acidic sealing compound.

## Note

After the first dynamic load the terminal **MUST** be tightened again. The terminal was developed for use with the following types of cable: 1x19, 7x19, 7x7. The terminal can also be used with Dyform (MBL 1570 N/mm<sup>2</sup>). When assembling Swageless Terminals the breaking strength of the cable used will be reduced by 0-15%. Refer to the table for the breaking strength of the terminal.



The user is responsible for choosing the proper cable diameter and for correct assembly





# BLUE WAVE®

## SWAGELESS CONE TERMINAL

The Swageless Cone Terminal is designed for use on 1x19 wire construction as well as compacted and Dyform wires. The user is responsible for proper use and installation of the components. Blue Wave does not take responsibility for damaged threads, due to overtightening or lack of Loctite. Blue Wave does not recommend to seal the terminal, but advise to rinse the terminal regularly with fresh water and treat with WD40.



Cone-house

Cone

Eye



**For loctite and lubricant, please order SCKIT**



1

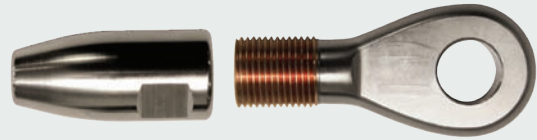

Apply Loctite 262 on threads and lightly screw the two parts together. Unscrew and check both threads are filled with Loctite.

2

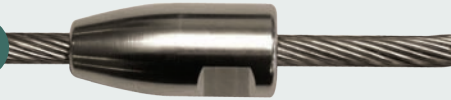

Slide the Cone housing over the wire.

3



Open the outer strands one by one. A screwdriver is helpful for this job.

4

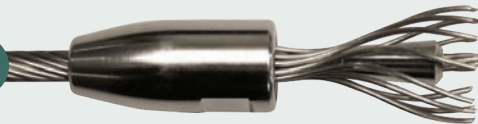

Place the Cone over the center core of the wire, rotating the cone while pushing.

5

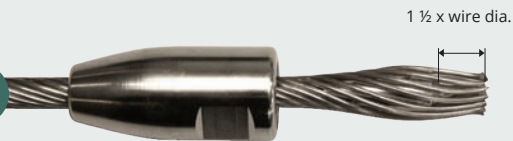

Twist the outer strands back over the cone. Make sure that all strands are evenly distributed over the cone. The end of the wire must be  $1 \frac{1}{2}$  x the wire diameter over the top of the cone. Check this distance with callipers.

6



Fill the wire former hole with BlueWave lubricant. The terminal is now ready to be assembled.

Using appropriate tools, screw the two parts together tightly. To ensure total security apply one last half turn. However, do not overtighten threads with excessive force.

NOTE: the former (top part) must be screwed all the way into the housing - max. 2 - 3 threads visible!

7



As a precaution take the terminal apart and visually check that the strands lay evenly around the cone and fit into the wire former (top part). Finally re-assemble as above and allow the Loctite to dry.



# BLUE WAVE®

## ROPE END FITTING

- New innovative product
- More opportunities to benefit from UHMWPE and UHMW ropes
- Unique and slim design
- Easy and viable to use and assemble
- AISI 316L stainless steel and hard anodized aluminium materials
- Easy to fit to existing rigging screws and deck fittings
- Backed by a full range of high quality rigging hardware



Community Design Registration 14/6 2017  
design reg. -004048098-0001



### "KEEP IT SIMPLE"



House

Bone

Eye



1

Slide the housing over the rope



2

Splice around the bone - following your rope suppliers general splice guidelines



3

Pull spliced bone back in housing

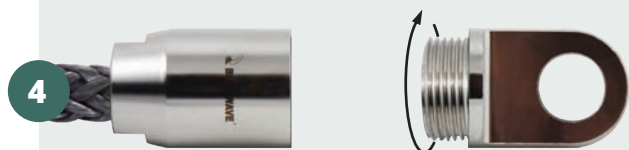

4

Screw the parts together - threads can be locked with Loctite



# BLUE WAVE HIGH QUALITY LUBRICANT

Synthetic oil based lubricant with PTFE

The Blue Wave lubricant contains PTFE micro powder dispersed in synthetic base oil with anti-oxidation additives. This highly effective lubricant with long life properties is used for metal to metal applications. It is water-repellent, does not soil and resists temperatures between - 50°C and +200°C. Furthermore, it is non-ageing and has extremely low friction.

The lubricant is supplied in tubes of either 5, 30 or 50 gr.

Whenever stainless steel threaded parts are screwed together it is always strongly recommended to lubricate the threads first as this prevents the threads from jamming.

## BWLUB

ART. NO.	NET. WEIGHT	LB/100
BWLUB1	50g	5
BWLUB2	30g	3
BWLUB3	5g	0,5



## SCKIT

ART. NO.	NET. WEIGHT	KG/100
SCKIT	6g	6

SCKIT contains lubricant and thread seal for one time use e.g. for swageless cone terminal assembly



Blue Wave products can be used in temperatures ranging from -40°C to +100°C and briefly up to 200°C

## RIGGING SCREWS FORK/FORK

Polished stainless steel - AISI 316

ART. NO.	G	PIN	A	B	L1	L2	BL/KG	KG/100	PACK
120005	M5	5	7,5	12	188	126	800	5,1	10
120006	M6	5	7,5	12	210	142	1000	9	10
120006X	M6	6	9,5	13	213	145	1250	14	10
120008	M8	6	9,5	13	251	170	1600	14	10
120008X	M8	8	11	15	258	178	2200	15	10
120010	M10	8	11	15	272	197	3200	24	10
120010X	M10	9,5	12	19	286	204	3500	26	10
120012	M12	12	14	25	359	251	5100	52,5	5
120012X	M12	14	18	32	375	269	5100	72,2	5
120014	M14	12	14	25	400	280	6900	63,5	5
120014X	M14	14	18	32	413	295	6900	84,5	5
120016	M16	14	18	32	480	320	9400	100	5
120016L	M16	14	22	30	472	312	9400	100	5
120016X	M16	16	18	33	479	319	9400	100	5
120020	M20	19	24	48	550	390	14000	197	BULK
120020L	M20	19	30	47	559	389	14000	197	BULK
120022	M22	22	30	57	653	472	18000	448	BULK
120024	M24	25,4	30	62	796	539	21000	638	BULK
120027	M27	28	32	68	825	590	23000	501	BULK
120030	M30	32	35	76	907	647	28000	1060	BULK
120036	M36	35	40	86	990	715	41000	1657	BULK

Note: All break loads are determined by clevis pin and thread

! M20> M36 Available with threaded bronze inserts in a stainless steel body

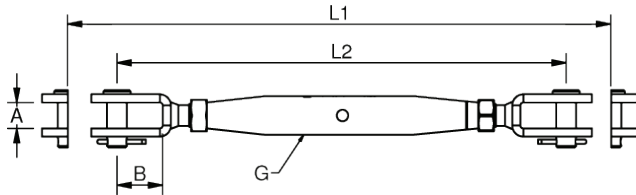

The larger size rigging screws from M20 and up are designed with a rounded fork head and are available with bronze threaded inserts for smooth adjustment.

Most rigging screws are also available with open body and UNF thread on request.



The Blue Wave stainless steel rigging screws have been setting standards over the last 50 years.

Available with a wide range of end fittings, the most common ones are listed in this catalogue. You can "put together" your own choice of complete rigging screw, as the loose threaded rigging screw parts are all to be found in the WDS catalogue.

Blue Wave rigging screws all feature thread and/or wire size as well as "easy use" marking for left and right threaded side.

A special Teflon® lubricate is used on the threads improving the performance. Whenever stainless steel threaded parts are screwed together it is always strongly recommended to lubricate the threads first as this prevents the threads from jamming!



## RIGGING SCREWS FORK/FORK - SMALL

Polished stainless steel - AISI 316L

ART. NO.	G	PIN	A	B	L1	L2	BL/KG	KG/100
A12120505	M5	5	7,5	12	143	106	800	3,7
A12120506	M6	5	7,5	12	155	111	1250	5,7
A12120606	M6	6	9,5	13	159	115	1250	6,7
A12120808	M8	8	11	15	186	140	2350	11,3
A12121010	M10	8	11	15	204	157	2350	19,2
A12121212	M12	9,5	12	19	248	200	3500	32,1

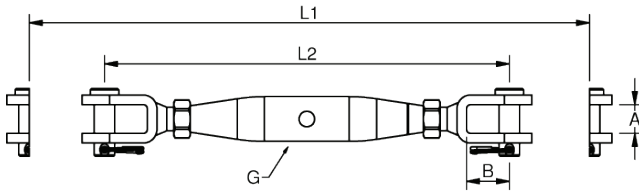

A short version of the classic closed rigging screw.



## RIGGING SCREWS FORK/FORK - MACHINED

Polished stainless steel - AISI 316

ART. NO.	G	PIN	A	B	L1	L2	BL/KG	KG/100	PACK
740020	M20	19	20	45	619	453	12000	330	BULK
740022	M22	22	22	49	637	456	15000	892	BULK
740024	M24	25	25	52	763	530	18000	1193	BULK
740027	M27	28	30	55	813	578	23000	1803	BULK
740030	M30	32	35	67	918	656	28000	2614	BULK
740036	M36	35	35	67	970	696	41000	3390	BULK
M740048	M48	46	43	106	1268	924	70000	4936	BULK
M740052	M52	53	46	122	1412	1026	80000	5388	BULK
M740056	M56	53	46	122	1476	1066	90000	7073	BULK
M740060	M60	60	54	132	1578	1154	115000	4608	BULK

Note: All break loads are determined by clevis pin and thread  
Body with threaded bronze inserts

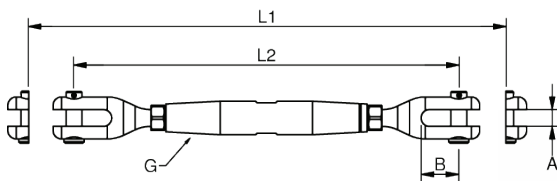

As demand for larger wire sizes has been growing, so has the range of larger machined fittings by Blue Wave.

Body with threaded bronze inserts.

From Ø28 mm wire / M48 forks are supplied with countersunk and double headed pins.



## RIGGING SCREWS FORK/TERMINAL

Polished stainless steel - AISI 316

ART. NO.	G	WIRE	PIN	A	B	D	L1	L2	BL/KG	KG/100	PACK
120205	M5	2	5	7,5	9,4	5,5	198	144	800	4,5	10
122505	M5	2,5	5	7,5	9,4	5,5	201	147	800	4,6	10
120306	M6	3	5	7,5	9,4	6,35	232	170	1200	8,5	10
120306X	M6	3	6	9,5	10,4	6,35	233	171	1200	8,5	10
120406	M6	4	5	7,5	10,4	7,5	242	180	1200	8,7	10
120406X	M6	4	6	9,5	10,4	7,5	242	180	1200	9,1	10
120408	M8	4	6	9,5	10,4	7,5	275	199	1600	13	10
120408X	M8	4	8	11	12,2	7,5	277	201	1700	13	10
120508	M8	5	6	9,5	13	9	281	205	1600	13,2	10
120508X	M8	5	8	11	12,2	9	284	208	2200	14,8	10
120510	M10	5	8	11	14	9	312	228	2500	22,5	10
120510X	M10	5	9,5	12	14	9	316	232	2500	22,5	10
120610	M10	6	8	11	15	12,58	327	243	3200	25,6	10
120610X	M10	6	9,5	12	18,5	12,58	330	250	3500	27,4	10
120612	M12	6	12	14	25	12,58	393	287	5100	47,5	5
120712	M12	7	12	14	25	14,2	401	295	5100	50	5
120812	M12	8	12	14	25	16	416	310	5100	53,5	5
120714	M14	7	12	14	25	14,2	439	319	6800	58	5
* 120714X	M14	7	14	18	33	14,2	453	335	6800	68,8	5
120814	M14	8	12	14	25	16	453	333	6800	63,5	5
* 120816	M16	8	14	18	32	16	498	365	8700	89,5	5
* 120816L	M16	8	14	22	30	16	494	361	8700	89,5	5
120816X	M16	8	16	18	33,3	16	499	366	8700	89,5	5
121016	M16	10	14	18	33	17,8	506	373	9400	93	5
121016L	M16	10	14	22	33	17,8	504	371	9400	93	5
121016X	M16	10	16	18	33	17,8	510	376	9400	93	5
121020	M20	10	19	24	48	17,8	587	427	9700	170,1	BULK
121220	M20	12	19	24	48	20	606	446	11400	170,1	BULK
* 121220X	M20	12	19	24	48	21,4	622	462	14200	170,1	BULK
121422	M22	14	22	30	46	25	736	555	15900	452	BULK
* 121622	M22	16	22	30	57,5	28	696	588	18000	490	BULK
121424	M24	14	25,4	30	47,8	25	846	613	15900	642	BULK
121624	M24	16	25,4	30	47,8	28	874	641	19400	662	BULK
121927	M27	19	28	32	68	34,5	968	734	23000	500	BULK
122027	M27	20	28	32	68	34,5	968	734	23000	646,9	BULK
122230	M30	22	32	35	76	40,5	1076	814	28000	1074	BULK
122636	M36	26	35	40	86	46	1195	921	41000	1682	BULK

\* Note: Terminal OD. = 21,4 mm

! M20> M36 Available with threaded bronze inserts in stainless steel body



The price favorable and durable stainless steel turnbuckle line from Blue Wave has been a favorite among riggers and yachtsmen for more than 50 years.

All AISI 316L/A4 material - BL tested and features; laser engraved thread size, LH thread side marking.

Turnbuckles with terminals show wire size and outside wire hole depth marking for easy handling.

Supplied with streamlined Blue Wave lock nuts.

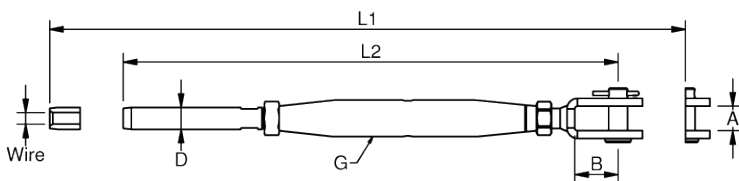

## RIGGING SCREWS FORK/TERMINAL - SMALL

Polished stainless steel - AISI 316L

ART. NO.	G	WIRE	PIN	A	B	D1	L1	L2	L3	BL/KG	KG/100	
A120305	M5	3	1/8"	5	7,5	12	5,5	153	117	25	360	3,1
A120406	M6	4	5/32"	5	7,5	12	6,35	166	122	25	640	4,9
A120506	M6	5	3/16"	6	9,5	13	7,5	176	132	30	1000	5,9
A120608	M8	6	-	8	11	15	9	209	163	40	1400	10,4
A120810	M10	8	5/16"	8	11	15	12,58	235	187	50	2300	18,7
A121012	M12	10	-	9,5	12,5	19,5	16	264	216	60	3600	31,8

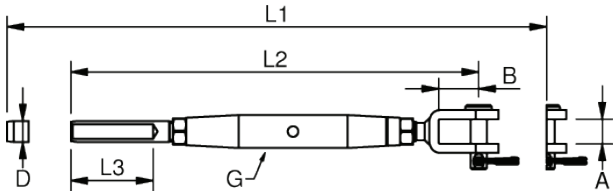

A short version of our classic rigging screw with small terminal. Suitable for hand crimping with Blue Wave Arctool1ACC & Arctool8 or roll swaged using a standard machine and smaller die.



## TAMPER PROOF RIGGING SCREW BODY

Polished stainless steel - AISI 316L

ART. NO.	G	PIN	A	B	D1	D2	L1	BL/KG	KG/100	PACK
BST0506	M6	5	5	12	12	15	90	1200	5,8	25

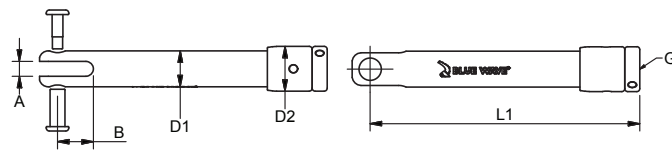

The one sized rigging screw is supplied with special lock nut and tamper proof press pins. Replacement pins, see page 76



## TERMINAL FOR TAMPER PROOF RIGGING SCREW

Polished stainless steel - AISI 316L

ART. NO.	WIRE	D	G	L1	L2	L3	BL/KG	KG/100	PACK
900306XL	3 - 1/8"	6,35	M6	127	75	38	1200	2,7	25
900406XL	4 - 5/32"	7,5	M6	137	75	45	1200	3,2	25
900506XL	5 - 3/16"	9	M6	143	75	51	1200	4,1	25

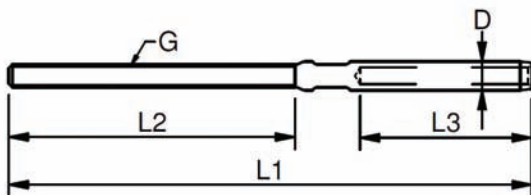

## RIGGING SCREWS FORK/TERMINAL - MACHINED

Polished stainless steel - AISI 316

ART. NO.	G	WIRE	PIN	A	B	D	L1	L2	BL/KG	KG/100	PACK
741220	M20	12	19	20	45	20	646	492	11400	240	BULK
741422	M22	14	22	22	49	25	720	540	15000	649	BULK
741622	M22	16	22	22	49	28	745	565	15000	670	BULK
741624	M24	16	25	25	52	28	863	630	18000	876	BULK
741927	M27	19	28	30	55	34,5	963	728	23000	1332	BULK
742230	M30	22	32	35	67	40,5	1082	820	28000	1888	BULK
742636	M36	26	35	35	67	46	1186	912	41000	2484	BULK
M742848	M48	28	46	43	106	50	1441	1095	70000	3261	BULK
M743052	M52	30	53	46	122	58	1590	1204	80000	4294	BULK
M743256	M56	32	53	46	122	58	1682	1264	90000	4852	BULK
M743660	M60	36	60	54	132	65	1807	1373	115000	6133	BULK

Note: All break loads are determined by clevis pin and thread  
Body with threaded bronze inserts

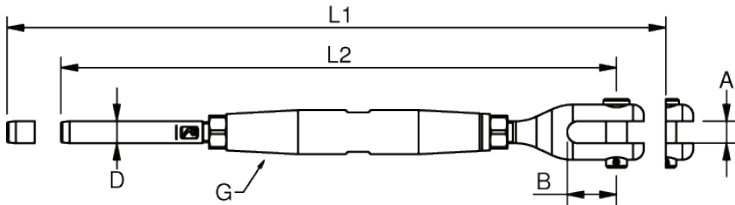

As demand for larger wire sizes has been growing, so has the range of larger machined fittings by Blue Wave. The machined forks are, as most fittings by Blue Wave, marked with wire size and swage depth marking for ease of use.

Body with threaded bronze inserts.

From Ø28 mm wire / M48 forks are supplied with countersunk and double headed pins.



## RIGGING SCREWS TOGGLE/TERMINAL

Polished stainless steel - AISI 316

ART. NO.	G	WIRE	PIN	A	B	D	L1	L2	BL/KG	PACK
320306	M6	3	6,35	8	17	6,35	271	201	1200	BULK
320408	M8	4	8	10	20	7,5	310	240	1700	BULK
320510	M10	5	9,5	12	26	9	361	278	2500	BULK
320612X	M12	6	12,7	18	35	12,58	448	340	5100	BULK
320712X	M12	7	12,7	18	35	14,2	456	348	5100	BULK
320812X	M12	8	12,7	18	35	16	471	363	5100	BULK
320816X	M16	8	16	20	41	16	566	436	8000	BULK
321020X	M20	10	19	24	45	17,8	642	488	9700	BULK
321220X	M20	12	19	24	45	20	661	507	11400	BULK
321220XX	M20	12	19	24	45	21,4	677	523	14200	BULK
321422X	M22	14	22	26	49	25	808	627	15900	BULK
321624X	M24	16	25,4	29	59	28	963	730	19400	BULK
321927X	M27	19	28	34	60	34,5	1071	836	25500	BULK
322230X	M30	22	32	40	69	40,5	1193	931	31000	BULK
322636X	M36	26	36	44	77	46	1319	1045	43000	BULK

M20 > M24 Available with threaded bronze inserts in stainless steel body

Note: All break loads are determined by clevis pin and thread

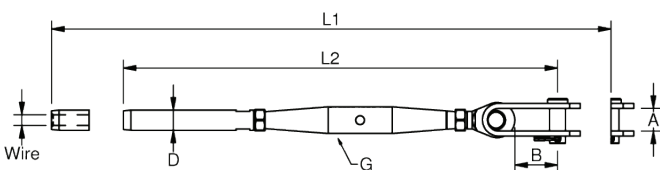

Blue Wave rigging screws bodies feature thread size, "easy use" marking for left and right threaded side and adjustment hole. From M20 upwards the bodies are available with chrome bronze threaded inserts and spanner flat on body.



## WELDED FORK TERMINALS

Polished stainless steel - AISI 316

ART. NO.	WIRE	PIN	A	B	D	L1	L2	BL/KG	KG/100	PACK	
100502	2	1/16"	5	7,5	12	5,5	50	24	800	2	25
100525	2,5	3/32"	5	7,5	12	5,5	53	27	800	2	25
100503	3	-	5	7,5	12	6,35	67	38	800	2,3	25
100532	-	1/8"	5	7,5	12	6,35	68	38	800	2,3	25
100603	3	-	6	9,5	13	6,35	68	38	1300	2,8	25
100632	-	1/8"	6	9,5	13	6,35	68	38	1300	2,8	25
100504	4	5/32"	5	7,5	12	7,5	71	45	800	2,7	25
100604	4	5/32"	6	9,5	13	7,5	73	45	1500	3,4	25
100804	4	5/32"	8	11	15	7,5	77	45	1700	4,9	25
100605	5	3/16"	6	9,5	13	9	83	51	1500	4,1	25
100805	5	3/16"	8	11	15	9	87	51	2400	5,5	10
109505	5	3/16"	9,5	12	19	9	91	51	2400	7,2	10
100806	6	-	8	11	15	12,58	99	64	3200	10	10
109506	6	-	9,5	12	19	12,58	104	64	3800	11,3	10
101206	6	-	12	14	25	12,58	110	64	5200	17,6	10
101207	7	9/32"	12	14	25	14,2	119	70	6500	18,1	10
101208	8	5/16"	12	14	25	16	136	83	6500	21,6	10
101408	8	-	14	18	33	16	143	83	8000	32,5	10
101608	8	5/16"	16	17	33	16	145	83	8000	25,5	10
101410	10	-	14	18	32	17,8	151	89	9400	35	10
101410L	10	-	14	22	30	17,8	149	89	9400	36	10
101610	10	-	16	17	33	17,8	149	89	9400	36,6	10
101910	10	-	19	24	48	17,8	168	89	9400	47,7	5
101612	12	-	16	17	33	20	174	105	11200	60	5
101612L	12	-	16	22	31	20	171	105	11200	60	5
101912	12	-	19	24	48	20	189	105	11200	66	5
101912L	12	-	19	30	47	20	187	105	11200	66	5
*101912X	12	-	19	24	48	21,4	205	120	14000	75	5
101914	14	-	19	24	50	25	221	140	15000	75	5
101914L	14	-	19	30	47	25	221	140	15000	75	5
102214	14	-	22	30	57	25	232	140	15000	112,7	5
102216	16	-	22	30	57	28	260	160	19400	141	5
102514	14	-	25,4	30	62	25	235	140	15000	125	5
102516	16	-	25,4	30	62	28	264	160	19000	140	5
102819	19	-	28	32	68	34,5	309	200	27000	246	BULK
102820	20	-	28	32	38	34,5	309	200	25000	244	BULK
103222	22	-	32	35	76	40,5	354	230	34000	372	BULK
103526	26	-	35	40	86	46	420	280	45000	548	BULK

\*: Note: Terminal OD = 21,4

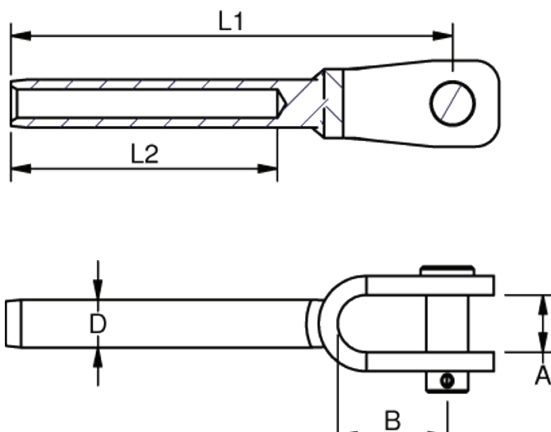

The wide range of hand welded fork terminals by Blue Wave has been setting standards for many years. Featured here are the most common sizes and fork variations; all with wire size and swage depth marking.

Small fork head design is "square", from  $\varnothing$  19 mm pin and up the design is "rounded".

Fork terminals are amongst the most commonly used wire end fittings. They are normally attached to pre drilled anchor plates or steel constructions. Also used in combination with toggles, eyes or U-bolts.



## FORK TERMINALS - MACHINED

Polished stainless steel - AISI 316

ART. NO.	WIRE	PIN	A	B	D	L1	L2	BL/KG	KG/100	PACK
721912	12	19	20	45	20	197	105	9500	100	BULK
722214	14	22	22	49	25	239	140	15000	170	BULK
722516	16	25,4	25	52	28	271	160	19000	210	BULK
722819	19	28	30	55	34,5	327	200	27000	330	BULK
723222	22	32	35	67	40,4	377	230	35000	480	BULK
723526	26	35	35	67	46	434	280	48000	700	BULK
M724628	28	46	43	106	50	499	295	70000	1191	BULK
M725330	30	53	46	122	58	542	315	80000	1756	BULK
M725332	32	53	46	122	58	562	335	90000	1758	BULK
M726036	36	60	54	132	65	630	375	115000	2513	BULK

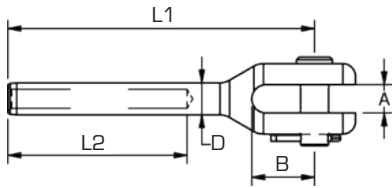

As demand for larger wire sizes has been growing, so has the range of larger machined fittings by Blue Wave. The machined forks are, as most fittings by Blue Wave, marked with wire size and swage depth marking for ease of use. From Ø28 mm wire/M48 forks are supplied with countersunk and double headed pins.



## FORK TERMINALS - WELDED - SMALL

Polished stainless steel - AISI 316

ART. NO.	WIRE	PIN	A	B	D1	L1	L2	BL/KG	KG/100
A360503	3	5	7,5	12	5,5	50	25	360	1
A360504	4	5	7,5	12	6,35	50	25	640	1,5
A360605	5	6	9,5	13	7,5	58	30	1000	2,2
A360806	6	8	11	15	9	72	40	1400	3,7
A360808	8	8	11	15	12,58	85	50	2300	8
A361010	10	9,5	12	19,5	16	106	60	3600	14,1

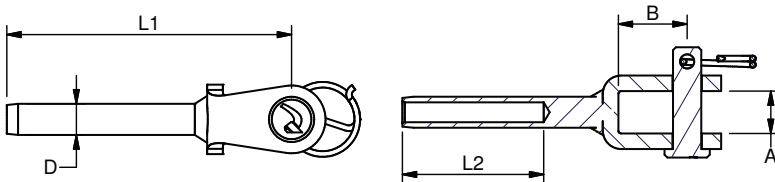

Blue Wave's small fork terminals are for lighter architectural fixing of wires. The focus of the design is the size. Overall dimensions have thus been reduced to a minimum. The small fittings are suitable for hand crimping with Blue Wave Arctool1ACC & Arctool8 or roll swaged using a standard machine and smaller die.





## FORK TERMINALS - MACHINED - SMALL

Polished stainless steel - AISI 316

ART. NO	WIRE	PIN	A	B	D1	D2	L1	L2	BL/KG	KG/100
A390503	3	5	5,5	12	5,5	11	48	25	360	1,03
A390504	4	5	6,5	15	6,35	13	53	25	640	1,43
A390505	5	5	6,5	15	7,5	13	57	30	1000	2,23
A390606	6	6	8,5	19	9	16	75	40	1400	3,66

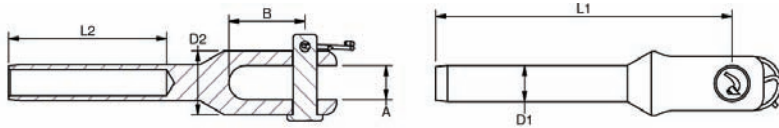

Blue Wave's small fork terminals are for lighter architectural fixing of wires. The focus of the design is the size. Overall dimensions have thus been reduced to a minimum. The small fittings are suitable for hand crimping with Blue Wave Arctool1ACC & Arctool8 or roll swaged using a standard machine and smaller die.



## TAMPER PROOF FORK TERMINAL

Polished stainless steel - AISI 316

ART. NO.	WIRE	PIN	A	B	D	L1	L2	BL/KG	KG/100	PACK	
BST720503	3	1/8"	5	5	12	6,35	61	38	1200	1,9	BULK
BST720504	4	5/32"	5	5	12	7,50	68	45	1200	2,4	BULK

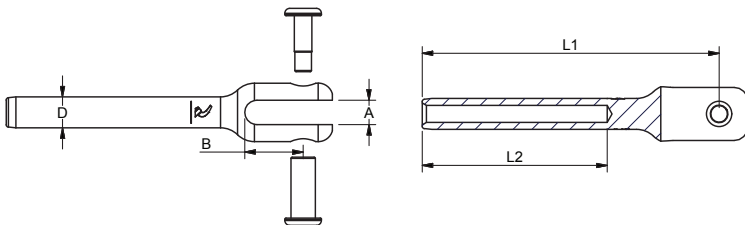

## AIRCRAFT FORK TERMINAL - ACCORDING TO MS20667

Polished stainless steel - AISI 316

ART. NO.	WIRE		PIN	D1	L1	L2	A	B	BL/KG	KG/100	PACK
	mm	inch									
ACF4516		1/16"	5	4	40	26	2,5	12,7	600	0,7	10
ACF4502	2		5	5,5	49	32	2,8	12,7	1190	1,2	10
ACF4525	2,5	3/32"	5	5,5	49	32	2,8	12,7	1050	1,2	10
ACF4503	3		5	6,35	60	38	5,2	18,7	1380	1,8	10
ACF4532		1/8"	5	6,35	60	38	5,2	18,7	1320	1,7	10
ACF0604	4	5/32"	6,35	7,5	67	45	5,2	18	1730	2,5	10
ACF0805	5	3/16"	8	9	78	51	6,35	22,2	2492	4,5	10
ACF0855		7/32"	8	10,8	87	57	7,9	24,6	3900	6,8	10
ACF9506	6		10	12,58	97	64	7,9	27	5460	10,7	10
ACF95635		1/4"	10	12,58	97	64	7,9	27	5270	10,6	10
ACF1107	7	9/32"	11	14,2	105	70	8,3	25,4	6840	15,1	10
ACF1108	8	5/16"	11	16	113	76	8,7	32,1	8650	19,3	10
ACF1395		3/8"	12,7	17,8	135	89	9,5	38,9	10200	27,5	10
ACF1410	10		14	20	163	102	9,5	45,2	13647	44,7	5
ACF1411		7/16"	14	20	163	102	9,5	45,2	12600	43,2	5
ACF1612	12		16	21,4	176	119	11,9	48,4	14210	50,6	5
ACF1613		1/2"	16	21,4	176	119	11,9	48,4	12980	48,6	5

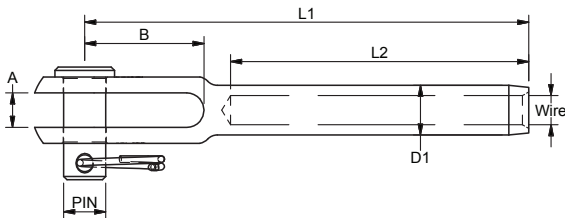

## SWAGELESS FORK TERMINALS

Polished stainless steel - AISI 316

ART. NO.	WIRE	PIN	A	B	L1	L2	L3	KW1	KW2	BL/KG	KG/100	ART.NO.RE-FIT JAWS	
840603	3	1/8"	6	6	8	55	63	29	12	14	750	5,5	080003
840804	4	5/32"	8	8	8	62	73	35	14	19	1500	7,3	080004
841005	5	-	10	10	10	72	83	42	16	22	2180	15	080005
841206	6	1/4"	12	12	12	82	95	48	19	27	3700	23	080006
841207	7	9/32"	12	12	13	102	115	55	21	29	4700	29	080007
841408	8	5/16"	14	14	14	103	118	58	24	30	5600	38	080008
841610	10	-	16	16	16	117	135	70	27	36	8300	63	080010
841912	12	-	19	18	16	142	162	75	32	42	12000	97	080012
842214	14	-	22	21	19	162	191	88	36	46	14000	135	080014
842516	16	-	25	23	22	184	217	102	41	55	23000	215	080016

Note: All break loads are determined by wedges (jaws) and clevis pin

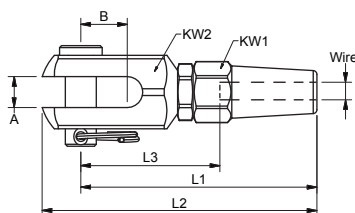

Safe, reliable and machine free swaging of wire with the fastest swageless system on the market. The Blue Wave swageless fork terminals are Lloyd's approved and ideal for site work where a professional swaging tool would normally be required. See instructions page 14.



## WELDED SWAGELESS FORK TERMINALS

Polished stainless steel - AISI 316

ART. NO.	WIRE	PIN	A	B	L1	KW	BL/KG	KG/100
840504	4	5	7,5	12	56,8	14	800	4,3
840505	5	5	7,5	12	56,8	14	800	4,5

Note: 7x7 and 7x19 only

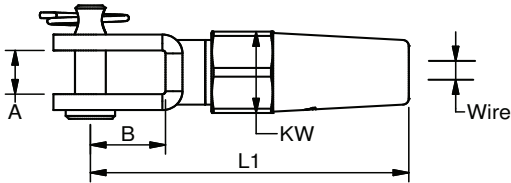

Small welded version of the swageless fork terminal.  
 Ø4 and Ø5 mm soft wires only.  
 See instruction page 14.



## SWAGELESS FORK TERMINAL WITH CONE

Polished stainless steel - AISI 316

ART. NO.	WIRE	PIN	A	B	C	KW	L1	L2	BL/KG	KG/100
SC842516	16 - 5/8"	25,4	22	47	26,5	42	200	100	28000	215,1
SC842819	19 - 3/4"	28	27	59	32,5	44	236	115	30000	292
SC843522	22 - 7/8"	34,8	32	72	70	50	275	125	38000	487,4
SC843526	26 - 1"	34,8	32	72	40	66	292	150	48000	693

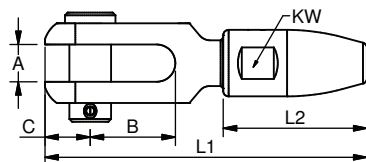

In addition to the Lloyd's approved swageless system, the swageless cone terminal for 1x19 wire construction enables safe and reliable wire attachment up till Ø 26 mm diameter.  
 See instructions page 15.





## WDS ADJUSTER FORKS

Polished stainless steel - AISI 316

NO. RIGHT	NO. LEFT	G	PIN	A	B	H	D1	L1	L2	L3	L4	KW	BL/KG	KG/100
C700606	C710606	M6	6	6	12	5	14	43	20	35	26	10	1200	3,7
C700808	C710808	M8	8	7	15	7	18	54	25,5	43,5	32	13	2200	7,7
C701010	C711010	M10	10	8	18	8	22	66	31	53	39	16	3400	14,6
C701212	C711212	M12	12	10	22	10	26	78	37	63	46	19	5000	22,8
C701616	C711616	M16	16	12	27	12	34	100	46,5	80,5	59	23	9400	51,5
C702020	C712020	M20	20	15	33,5	14	42	122	57,5	98	72	29	14000	95,6
C702224	C712224	M24	22	25	45,5	16	55	150	75	120	75	36	21000	178,6

Note: All break loads are determined by clevis pin (fork) and thread  
 Note: Threaded tie bars in various lengths are available on request

As an alternative to wire systems, tie-bars may be used - especially for static structures such as balcony supports, glassed façade structures etc. Standard components are adjuster forks and inside threaded connectors for tie-bars. The tie bars are available on request, can be delivered with or without key width as well as in a polished or unpolished version. Adjuster eyes can also be delivered on request.

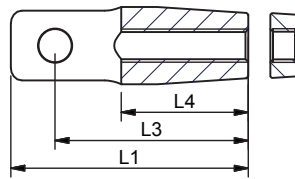
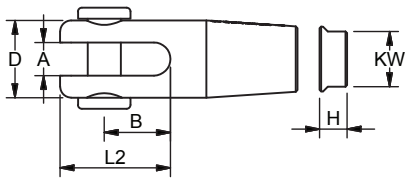

## CONNECTOR

Polished stainless steel - AISI 316

ART. NO.	G	D1	L1	L2	BL/KG	KG/100	PACK
087006	M6	11	26	9	1200	1,2	BULK
087008	M8	12,5	33	12	2200	1,8	BULK
087010	M10	17	39	15	3400	4	BULK
087012	M12	22	52	18	5000	9,6	BULK
087016	M16	28	65	24	9400	19,3	BULK
087020	M20	33,5	78	30	14000	32,2	BULK
087024	M24	44	104	36	21000	79	BULK

Note: Threaded tie bars in various lengths are available on request



## TIE BAR AISI 316

ART. NO.	DIM MM
TIExxx	Ø 6-24

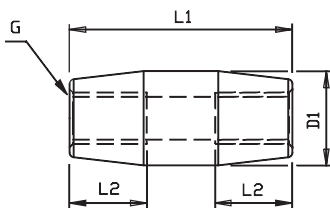

On request only:  
Thread lengths to suit  
adjuster forks

Tiebars M6-M24  
up to 3.000 mm  
are available on  
request.



## TOGGLE TERMINAL

Polished stainless steel - AISI 316

ART. NO.	WIRE	PIN	A	B	D1	D2	L1	L2	L3	BL/KG	KG/100	PACK	
500503G	3	-	5	7	11,5	3,5	6,35	78	38	12	1000	3,1	10
500532G	-	1/8"	5	7	11,5	3,5	6,35	78	38	12	1000	3,1	10
500603	3	-	6,35	8	17	3,5	6,35	81	38	14	1300	4,3	10
500632	-	1/8"	6,35	8	17	3,5	6,35	81	38	14	1300	4,3	10
500504G	4	5/32"	5	7	11,5	4,4	7,5	85	45	12	1000	3,5	10
506304G	4	5/32"	6,35	7	14	4,4	7,5	91	45	12	1400	4,8	10
500804	4	5/32"	8	10	25	4,4	7,5	94	45	18	1700	7,3	10
506305G	5	3/16"	6,35	10	14	5,3	9	99	51	12	1400	5,7	10
509505	5	3/16"	9,5	12	27	5,3	9	116	51	23	2400	13,8	10
506306G*	6	-	6,35	10	14	6,5	9	85	40	12	1400	6,9	10
501106X	6	-	11	15	29	6,5	12,58	135	64	30	5500	27,3	10
501206X	6	-	12,7	18	33	6,5	12,58	151	64	30	5500	33,4	5
501207X	7	9/32"	12,7	18	33	7,5	14,2	157	70	30	6200	35,7	5
501208D	8	5/16"	12,7	18	33	8,4	13	170,5	83	30	4600	36	5
501308	8	5/16"	12,7	18	33	8,4	16	170	83	30	6200	37,5	5
501608X	8	5/16"	15,9	20	41	8,4	16	198	83	35	8700	59,7	5
501610	10	-	15,9	20	41	10,5	17,8	192	89	35	9700	64,3	5
501910X	10	-	19	24	43	10,5	17,8	228	100	40	9700	100	BULK
501912	12	-	19	24	43	12,5	20	220	105	40	11400	98,8	BULK
501912X	12	-	19	24	43	12,5	21,4	240	120	40	14200	103	BULK
502214	14	-	22	26	47	14,8	25	277	140	50	15900	170,2	BULK
502516	16	5/8"	25,4	29	60	17	28	313	160	60	19400	265,5	BULK
502819	19	3/4"	28	34	63	20	34,5	399	200	60	25500	612	BULK
503222	22	7/8"	32	40	73	23,5	40,4	463	230	75	31000	570	BULK
503526	26	1"	36	44	80	27,5	46	518	280	85	43000	750	BULK

\*Note: Terminal OD = 9 mm

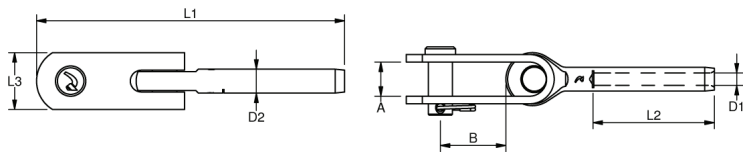

The flexible Blue Wave toggle terminal is marked with wire size and wire-hole depth making it easier to work with and to press or swage onto the wire. Its uses are for diagonal or angle installations and also to minimize the risk of fatigue due to sideways loads.



## SWAGELESS TOGGLE TERMINAL WITH CONE

Polished stainless steel - AISI 316

ART. NO.	WIRE	PIN	A	B	C	KW	L1	L2	BL/KG	KG/100	
SC830804	4	5/32"	8	10	20	9	12	85	27	2200	8,7
SC831047	-	3/16"	9,5	12	26	12	14	102	30	2800	16,1
SC831005	5	-	9,5	12	26	12	14	102	30	2800	16,1
SC831355	-	7/32"	12,7	18	36	18	17	132	38	5000	30,2
SC831306	6	-	12,7	18	36	18	17	132	38	5000	30,2
SC831363	-	1/4"	12,7	18	36	18	17	132	38	5000	30,2
SC831307	7	9/32"	12,7	18	35	18	19	145	46	6000	35,8
SC831308	8	5/16"	12,7	18	35	18	22	158	54	6000	42,5
SC831608	8	5/16"	16	20	41	20	22	173	54	8000	64,7
SC831695	-	3/8"	16	20	41	20	27	187	64	9800	77,5
SC831995	-	3/8"	19	24	45	25	27	202	64	11000	110,3
SC831610	10	-	16	20	41	20	27	187	64	9800	77,4
SC831910	10	-	19	24	45	25	27	202	64	11000	110,3
SC831911	-	7/16"	19	24	45	25	33	226	82	17000	141,4
SC831912	12	-	19	24	45	25	33	226	82	17000	141,4
SC831913	-	1/2"	19	24	45	25	33	226	82	17000	141,4
SC832214	14	9/16"	22	26	48	30	37	247	89	23000	203,2
SC832516	16	5/8"	25,4	29	61	37	42	285	100	28000	310,6
SC832819	19	3/4"	28	34	65	34	44	319	115	30000	413,7
SC833522	22	7/8"	34,8	44	83	41	50	377	125	38000	670,5
SC833526	26	1"	34,8	44	83	41	66	403	150	48000	886,6

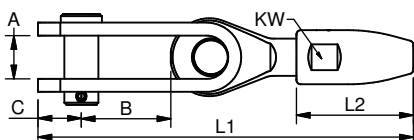

In addition to the Lloyd's approved swageless system, the swageless cone terminal for 1x19 wire construction enables safe and reliable wire attachment up till Ø 26 mm diameter. See instructions page 15.



## TOGGLES

Polished stainless steel - AISI 316

ART. NO.	PIN	A	B	C	BL/KG	KG/100	PACK
140006	6	7,5	28	6,5	1800	2,3	10
140008	8	8,5	34	7,5	2600	4	10
140010	9,5	10,5	45	9,5	4000	5,9	10
140011	11	11,5	50	10,5	4800	8,5	10
140012	12	13,5	56	12	5800	12,4	10
140016	16	17	63	15	8000	22,5	BULK
140019	19	21	69	18	13000	40,7	BULK
140022	22	25	111	25	17000	80,2	BULK
140025	25,4	30	104	25	29000	105	BULK
140028	28	32	121	30	36000	147	BULK
140032	32	38	133	33	48000	225	BULK

Note: All break loads are determined by clevis pin

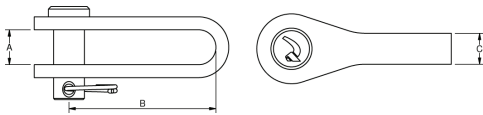

For lengthening the wire or adding flexibility to installations, the toggles can be applied. Where a structure is subjected to stress the use of a toggle is essential as it can minimise the fatigue risk.

## TOGGLES WITH EYE

Polished stainless steel - AISI 316

ART. NO.	PIN	A1	B	D	L1	L2	A2	BL/KG	KG/100	PACK
140506	5	7,5	12	5,5	26	9	5	1300	1,8	25
140608	6	9,5	13	6,5	32	10	6	1800	3	10
140810	8	11	15	8,5	36	12	8	3200	5,5	10
141011	9,5	12,5	19	10	45	16	9	3500	7,2	10
141111	11	12	23	11,5	51	17	9	5200	12,1	10
141214	12	14	25	13	59	23	10	5900	14,5	10
141414	14	22	30	14,5	78	28	14	7500	28	10
141616	16	22	30	16,5	84	30	16	9400	47,7	10

Note: All break loads are determined by clevis pin

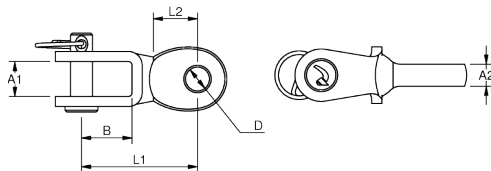

## RIGGING SCREWS EYE/EYE

Polished stainless steel - AISI 316

ART. NO.	G	A	D1	D2	L1	L2	BL/KG	KG/100	PACK
191905	M5	3	5,5	12	190	131	800	4	10
191906	M6	4	6,5	14	204	136	1200	11	10
191908	M8	5	8,5	17	244	164	2200	14	5
191910	M10	6	10,5	22	270	187	3500	23	5
191912	M12	8	13	25	334	226	5100	38	5
191914	M14	9	13	28	376	257	6800	51	BULK
191916	M16	10	14,5	31	408	278	9400	73	BULK
191920	M20	15	19,5	40	488	334	14700	105	BULK
191922	M22	18	23	47	597	416	15200	354	BULK
191924	M24	20	26	53	713	480	17700	670	BULK
191927	M27	25	28,5	65	759	527	23000	710	BULK
191930	M30	30	33	70	861	581	28000	991	BULK
191936	M36	30	36	80	892	618	41000	1288	BULK

Note: All break loads are determined by eye (D1) and thread

M20> M36 Available with threaded bronze inserts in a stainless steel body

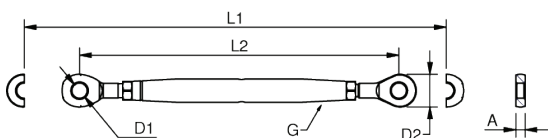

## RIGGING SCREWS EYE/TERMINAL

Polished stainless steel - AISI 316

ART. NO.	G	WIRE	A	D1	D2	D3	L1	L2	BL/KG	KG/100	PACK
190205	M5	2	3	2,2	5,5	5,5	205	143	800	3,7	BULK
192505	M5	2,5	3	2,8	5,5	5,5	208	146	800	3,4	BULK
190306	M6	3	4	3,5	6,35	6,5	234	166	1200	6,3	BULK
190406	M6	4	4	4,4	7,5	6,5	244	176	1200	6,7	BULK
190408	M8	4	5	4,4	7,5	8,5	282	202	1700	12,4	BULK
190508	M8	5	5	5,3	9	8,5	288	208	2200	13,4	BULK
190510	M10	5	6	5,3	9	10,5	311	227	2500	19,5	BULK
190610	M10	6	6	6,5	12,58	10,5	326	242	3400	23,4	BULK
190612	M12	6	8	6,5	12,58	13	379	271	5000	38,5	BULK
190712	M12	7	8	7,5	14,2	13	387	279	5000	40,8	BULK
190812	M12	8	8	8,4	16	13	400	292	5000	51,1	BULK
190714	M14	7	9	7,5	14,2	13	432	314	6800	46,7	BULK
190814	M14	8	9	8,4	16	13	446	328	6800	55,1	BULK
190816	M16	8	10	8,4	16	14,5	478	350	8700	74,6	BULK
191016	M16	10	10	10,5	17,8	14,5	495	367	9400	86,6	BULK
191020	M20	10	15	10,5	17,8	19,5	593	405	9700	126,9	BULK
1912T20	M20	12	15	12,5	20	19,5	573	419	11500	136,9	BULK
1912T20X	M20	12	15	12,5	21,4	19,5	599	435	14200	152,8	BULK
191422X	M22	14	18	14,8	25	23	708	527	15200	163,8	BULK
191624X	M24	16	20	17	28	26	846	613	17700	233,6	BULK
191927X	M27	19	25	20	34,5	28,5	934	702	23000	394	BULK
192230X	M30	22	30	23,5	40,5	33	1057	777	28000	1090,4	BULK
192636X	M36	26	30	27,5	46	36	1150	873	41000	1446,8	BULK

M20 > M36 Available with threaded bronze inserts in stainless steel body

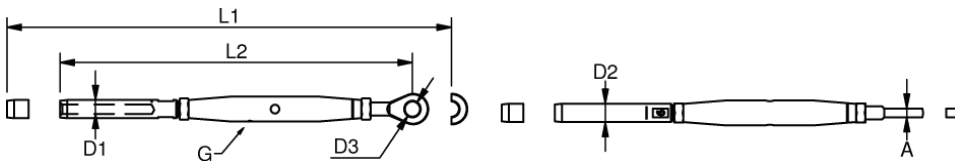

All AISI 316L/A4 Material - BL tested and features; laser engraved thread size, LH thread side marking.

Turnbuckles with terminals show wire size and outside wire hole depth marking for easy handling.

Supplied with streamlined Blue Wave lock nuts.



## RIGGING SCREWS EYE/FORK

Polished stainless steel - AISI 316

ART. NO.	G	PIN	A1	B	A2	D1	D2	L1	L2	BL/KG	KG/100	PACK
191205	M5	5	7,5	12	3	5,5	12	188	129	800	4,2	BULK
191206	M6	5	7,5	12	4	6,5	14	206	138	1000	6,3	BULK
191208	M8	6	9,5	13	5	8,5	17	244	164	1600	13	BULK
191210	M10	8	11	15	6	10,5	21	271	188	3200	21,9	BULK
191212	M12	12	14,5	25	8	13	25	343	235	5100	44	BULK
191214	M14	12	14,5	25	9	13	28	381	262	6900	60	BULK
191216	M16	14	18	33	10	14,5	31	426	296	9400	85,6	BULK
191220	M20	19	24	50	15	19,5	40	518	364	14000	169,3	BULK
191222	M22	22	30	57	18	23	47	625	444	15200	398,5	BULK
191224	M24	25,4	30	62	20	26	53	741	508	17700	580,0	BULK

M20 > M24 Available with threaded bronze inserts in stainless steel body

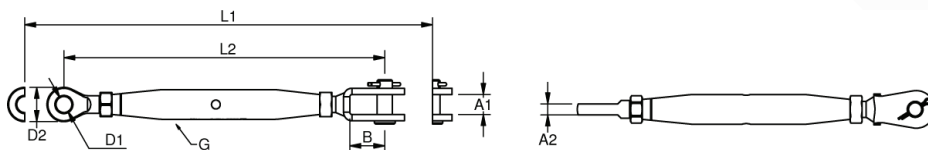

## EYE TERMINALS

Polished stainless steel - AISI 316

ART. NO.	WIRE	A	B	D1	D2	L1	L2	BL/KG	KG/100	PACK	
190002	2	1/16"	3	12	5,5	5,5	41	24	1200	0,9	100
190025	2,5	3/32"	3	12	5,5	5,5	44	27	1000	0,8	100
190003	3	-	4	14	6,35	6,5	60	38	1300	1,3	100
190332	-	1/8"	4	14	6,35	6,5	60	38	1300	1,4	100
190004	4	5/32"	5	17	7,5	8,5	67	45	1700	2,3	100
190005	5	3/16"	6	21	9	10,5	79	51	2400	3,9	25
190006	6	-	8	25	12,58	13	94	64	5500	8,7	10
190006X	6	-	10	28	12,58	13,2	105	64	5500	11,2	10
190007	7	9/32"	9	27	14,2	13	104	70	6800	11,5	10
190007X	7	9/32"	10	28	14,2	13,2	110	70	6800	13,5	10
190008	8	5/16"	10	30	16	14,5	124	83	8000	17	10
190008D	8	5/16"	10	30	13	14,5	123,5	83	4600	13,5	10
190008X	8	5/16"	12	36	16	16,5	141	83	8700	23,5	10
190010	10	-	11	35	17,8	16,3	137	89	9700	25	10
190010X	10	-	16	40	17,8	19,5	165	100	9700	38	10
190012	12	-	15	40	20	19,3	156	105	11400	41,5	5
190012X	12	-	15	42	21,4	19,5	178	120	14200	41	5
190014	14	-	18	47	25	23	206	140	15900	75,6	5
190016	16	-	20	53	28	26	232	160	19000	102	5
190019	19	-	25	65	34,5	28,5	302	200	31000	209	BULK
190020	20	-	25	65	34,5	28,5	302	200	31000	199,8	BULK
190022	22	-	30	70	40,4	33	348	230	42000	314	BULK
190026	26	-	30	77	46	36,5	400	280	53000	425	BULK
190028	28	-	35	84	50	41,5	445	300	64000	602,4	BULK



Blue Wave eye terminals are engraved with the wire size and swage depth, making them easier to work with and to press or swage onto the wire. Eyes are mainly used as an attachment to rigging screws or forks.

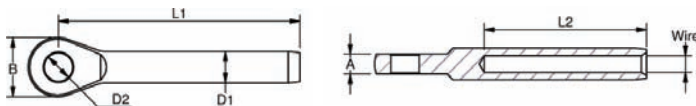

## EYE TERMINALS - SMALL

Stainless steel - AISI 316

ART.NO.	WIRE	B	D1	D2	L1	L2	L3	L4	A	KG/100	
A200503	3	1/8"	9	5,5	5,5	36	25	11	6	2,5	0,5
A200504	4	5/32"	10	6,35	5,5	38	25	12	6,5	3	0,7
A200505	5	3/16"	11	7,5	5,5	43	30	13	7	3,75	1
A200606	6	-	14	9	6,5	62	40	16	8,5	4,5	1,9



Blue Wave's small eye terminals are for lighter architectural terminations. The focus of the design is the size. Overall dimensions have thus been reduced to a minimum. The small fittings are suitable for hand crimping with Blue Wave Arctool Acc1 & Arctool8 or roll swaged using a standard machine and smaller die.

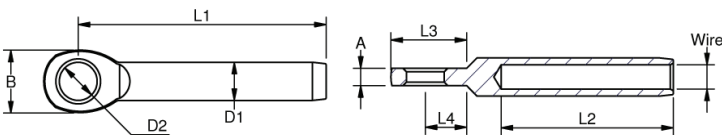



## SWAGELESS EYE TERMINALS

Polished stainless steel - AISI 316

ART. NO.	WIRE	A	D	L1	L2	L3	KW1	KW2	BL/KG	KG/100	ART.NO. RE-FIT JAWS
821903	3 1/18"	5,5	6,3	58	50	26,5	10	12	750	4	080003
821904	4 5/32"	7	8,3	68	58	31	13	14	1500	7,3	080004
821905	5 -	8	10,3	81	70	37	14	16	2180	9,8	080005
821906	6 1/4"	9	12,3	97	83	45	17	19	3700	15	080006
821907	7 9/32"	9	12,3	105	89	50,5	18	21	4700	21,2	080007
821908	8 5/16"	10	14,3	114	97,5	52,5	19	24	5600	28,1	080008
821910	10 -	13	16,3	135	116	65	24	27	8300	46	080010
821912	12 -	15	19,5	160	137	71,5	27	32	12000	72	080012
821914	14 -	18	22	185	160	85	30	36	14000	110	080014
821916	16 -	20	25	197	170	98	32	41	23000	160	080016

Note: All break loads are determined by wedges (jaws) and eye (D)

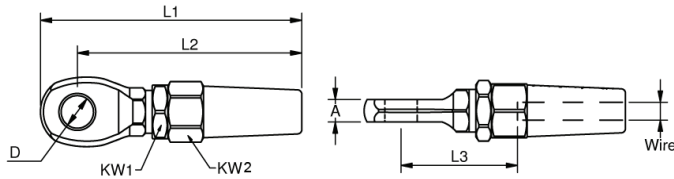

Safe, reliable and machine free swaging of wire, with the fastest swageless system on the market. The Blue Wave swageless eye terminals are Lloyd's approved and ideal for site work where a professional swaging tool would normally be required. See instructions page 14.



## SWAGELESS EYE TERMINAL WITH CONE

Stainless steel - AISI 316

ART. NO.	WIRE	D	T	KW	L1	L2	L3	L4	BL/KG	KG/100
SC822516	16 5/8"	26	20	42	187	100	28	69	28000	144,5
SC822819	19 3/4"	28,5	25	44	22	115	33	83	30000	215
SC823522	22 7/8"	35,5	30	50	250	125	40	100	38000	320
SC823526	26 1"	35,5	30	66	280	150	40	100	48000	535

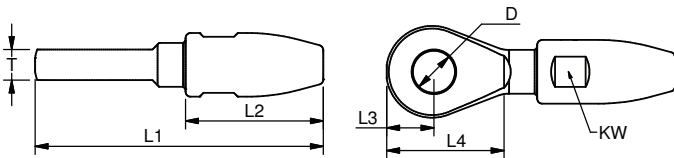

In addition to the Lloyd's approved swageless system, the swageless cone terminal for 1x19 wire construction enables safe and reliable wire attachment up till Ø 26 mm diameter. See instructions page 15.



## DYNEEMA ROPE EYE

Polished stainless steel - AISI 316

ART. NO.	Dyneema	A	D1	D2	D3	KW	L1	L2	BL/KG	KG/100
RP820804	Ø4	5	16	8,5	6	11	45	12	1900	3,8
RP821005	Ø5	6	21	10,5	8	16	58,5	14,5	3200	8,5
RP821206	Ø6	9	25	13	10	19	71	17,5	5500	15,5
RP821408	Ø8	10	39	14,5	16	29	103,5	29,5	9400	47,2
RP821610	Ø10	13	45	16,2	18	33	120	34	15000	75,5
RP821912	Ø12	15	54	19,5	21	40	136,5	38	18000	117,1
RP822214	Ø14	18	65	23	26	47	163	42	26000	207,5
RP822516	Ø16	20	77	26	30	55	192	58	32000	302,2

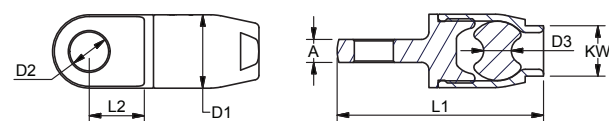

Benefiting from the knowledge on wire rope fittings Blue Wave has designed a fitting for use with Dyneema ropes. The eye can be used for Ø 4 mm to Ø 16 mm Dyneema rope and combined with other Blue Wave fittings. Separate rope folder available on request. See instructions page 16.



Community Design Registration 14/6 2017  
design reg. -004048098-0004



## RIGGING SCREWS TERMINAL/TERMINAL

Polished stainless steel - AISI 316

ART. NO.	G	WIRE	D1	D2	L1	L2	BL/KG	KG/100	PACK
120205T	M5	2	2,2	5,5	223	162	800	4	BULK
122505T	M5	2,5	2,8	5,5	228	165	800	4	BULK
120306T	M6	3	3,5	6,35	274	204	1200	6	BULK
120406T	M6	4	4,4	7,5	284	214	1200	8	BULK
120408T	M8	4	4,4	7,5	312	242	1700	13	BULK
120508T	M8	5	5,3	9	328	258	2200	15	BULK
120510T	M10	5	5,3	9	350	267	2500	21	BULK
120610T	M10	6	6,5	12,58	380	297	3500	21	BULK
120612T	M12	6	6,5	12,58	410	327	5100	42	BULK
120712T	M12	7	7,5	14,2	454	346	5100	47	BULK
120714T	M14	7	7,5	14,2	488	369	6800	57	BULK
120812T	M12	8	8,4	16	490	382	5100	55	BULK
120814T	M14	8	8,4	16	521	402	6900	65	BULK
120816T	M16	8	8,4	16	548	418	8700	83	BULK
121016T	M16	10	10,5	17,8	566	436	9400	87	BULK
121020T	M20	10	10,5	17,8	620	466	9700	135	BULK
121220T	M20	12	12,5	20	658	504	11400	149	BULK
121220XT	M20	12	12,5	21,4	658	504	14200	149	BULK
121422T	M22	14	14,8	25	820	639	15900	378	BULK
121622T	M22	16	17	28	870	689	18000	416	BULK
121624T	M24	16	17	28	979	746	19400	553	BULK
121927T	M27	19	20	34,8	1114	879	23000	801	BULK
122230T	M30	22	23,5	40,5	1245	983	28000	1179	BULK
122636T	M36	26	27,5	46	1402	1128	41000	1589	BULK

M20 > M36 Available with threaded bronze inserts in stainless steel body

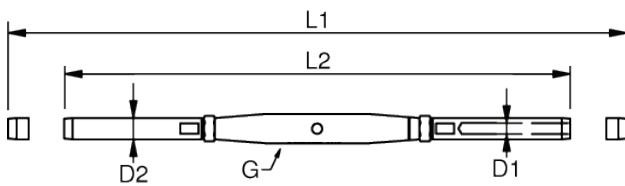

All AISI 316L/A4 Material - BL tested and features; laser engraved thread size, LH thread side marking.

Turnbuckles with terminals show wire size and outside wire hole depth marking for easy handling.

Supplied with streamlined Blue Wave locknuts.



# THREAD TERMINALS

Stainless steel - AISI 316

NO. RIGHT	NO. LEFT	G	WIRE	D1	D2	L1	L2	L3	KW	BL/KG	KG/100	PACK
900205	910205	M5	2	2,2	5,5	80	24	42	4,5	800	1,4	BULK
902505	912505	M5	2,5	2,8	5,5	82	27	42	4,5	800	1,5	BULK
900306	910306	M6	3	3,3	6,35	100	38	48	5	1200	2	BULK
900406	910406	M6	4	4,4	7,5	110	45	48	6	1200	2,4	BULK
900408	910408	M8	4	4,4	7,5	117	45	57	6	1700	3	BULK
900508	910508	M8	5	5,3	9	123	51	57	7	2200	4	BULK
900510	910510	M10	5	5,3	9	130	51	63	7	2500	4,5	BULK
900610	910610	M10	6	6,5	12,58	145	64	63	11	3500	8,4	BULK
900612	910612	M12	6	6,5	12,58	162	64	80	11	5100	11	BULK
900712	910712	M12	7	7,5	14,2	170	70	80	12	5100	13,3	BULK
900714	910714	M14	7	7,5	14,2	180	70	89	12	6800	16	BULK
900812	910812	M12	8	8,4	16	185	83	80	14	5100	19,2	BULK
900814	910814	M14	8	8,4	16	194	83	89	14	6900	20	BULK
900816	910816	M16	8	8,4	16	203	83	100	14	8700	23	BULK
901016	911016	M16	10	10,5	17,8	210	89	100	15	9400	35	BULK
901020	911020	M20	10	10,5	17,8	230	89	120	15	9700	35	BULK
901220	911220	M20	12	12,5	20	249	105	120	17	11400	45	BULK
901220X	911220X	M20	12	12,5	21,4	265	120	120	19	14200	50	BULK
901422	911422	M22	14	14,8	25	308	140	140	22	15900	76,8	BULK
901622	911622	M22	16	17	28	333	160	140	25	18200	97,8	BULK
901624	911624	M24	16	17	28	363	160	170	25	19400	111	BULK
901927	911927	M27	19	20	34,5	425	200	180	30	23000	209,0	BULK
902027	912027	M27	20	21	34,5	425	200	180	30	23000	206,1	BULK
902230	912230	M30	22	23,5	40,5	480	230	200	36	28000	314	BULK
902636	912636	M36	26	27,5	46	550	280	220	41	41000	470	BULK
M902848	M912848	M48	28	29,5	50	630	295	280	44	70000	781	BULK
M903052	M913052	M52	30	31,5	58	688	315	310	50	80000	1115	BULK
M903256	M913256	M56	32	33,5	58	730	335	330	50	90000	1239	BULK
M903660	M913660	M60	36	37,5	65	793	375	350	57	115000	1618	BULK

Note: Further sizes available on request



The wide range of threaded Blue Wave terminals are engraved with wire size and swage depth making them easy to use when pressing or swaging them onto the wire. The terminals are available with left handed or right handed threads and also with split pin hole or UNF thread on request. Threaded terminals are used to put tension on a wire either with the help of nuts and washers or as part of a rigging screw.

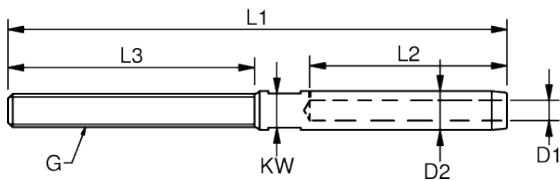

## THREAD TERMINALS - SMALL

Stainless steel - AISI 316

NO. RIGHT	NO. LEFT	G	WIRE	D1	D2	L1	L2	L3	BL/KG	KG/100	
A180503	A190503	M5	3	1/8"	3,5	5,5	60	25	30	360	0,8
A180604	A190604	M6	4	5/32"	4,4	6,35	65	25	35	640	1,2
A180605	A190605	M6	5	3/16"	5,3	7,5	73	30	35	1000	1,7
A180806	A190806	M8	6	-	6,5	9	88	40	40	1400	2,6
A181008	A191008	M10	8	5/16"	8,4	12,58	103	50	45	2300	5,8
A181210	A191210	M12	10	-	10,5	16	118	60	50	3600	10

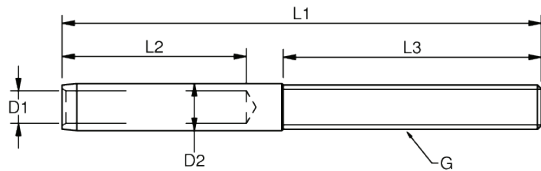

Blue Wave's small thread terminals are for lighter architectural fixing of wires. The focus of the design is the size. Overall dimensions have thus been reduced to a minimum. The small fittings are suitable for hand crimping with Blue Wave Arctool1ACC & Arctool8 or roll swaged using a standard machine and smaller die.



## RIGGING SCREWS SWAGELESS/BLANK

Polished stainless steel - AISI 316

### Left side blank

ART. NO.	G	WIRE	L1	L2	KW 1	KW 2	BL/KG	KG/100	PACK
870306	M6	3	168	134	12	10	750	6	BULK
870406	M6	4	175	141	14	12	1200	6,7	BULK
870408	M8	4	202	162	14	12	1500	11,6	BULK
870508	M8	5	211	171	16	13	2180	13,8	BULK
870510	M10	5	222	181	16	13	2180	18,5	BULK
870610	M10	6	233	192	19	16	3500	22,7	BULK
870612	M12	6	277	223	19	16	3700	33,5	BULK
870712	M12	7	277	223	21	19	4700	33,5	BULK
870714	M14	7	311	253	21	18	4700	44,1	BULK
870812	M12	8	294	240	24	19	5100	43,5	BULK
870814	M14	8	320	262	24	19	5600	49,5	BULK
870816	M16	8	348	283	24	19	5600	63,1	BULK
871016	M16	10	356	291	27	24	8000	75,7	BULK
871220	M20	12	417	340	32	27	12000	131,7	BULK
871422	M22	14	501	410	36	30	14000	334,6	BULK
871624	M24	16	598	463	41	32	20000	497,1	BULK

Note: All break loads are determined by thread and wedges (jaws)

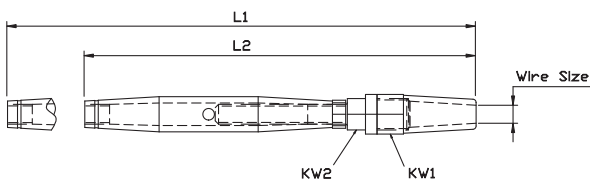

The "one side blank" rigging screw is assembled with a right threaded swageless terminal. It is ideal for site work where a professional swaging would normally be required and the final attachment has not been decided upon as the choice of fitting for the blank side is optional. See instructions page 14.



## SWAGELESS THREAD TERMINALS

Polished stainless steel - AISI 316

NO. RIGHT	NO. LEFT	G	WIRE	L1	L2	L3	KW	KW1	BL/KG	KG/100
800305	810305	M5	3	79	58	42	10	12	750	4,2
800306	810306	M6	3	85	63	47	10	12	750	4,5
800406	810406	M6	4	92	63	47	12	14	1200	5,6
800408	810408	M8	4	102	72	57	12	14	1500	6,6
800508	810508	M8	5	111	78	57	13	16	2180	9
800510	810510	M10	5	117	84	63	13	16	2180	10
800610	810610	M10	6	128	90	63	16	19	3500	15
800612	810612	M12	6	145	107	80	16	19	3700	17
800712	810712	M12	7	153	110	80	18	21	4700	22
800714	810714	M14	7	162	119	89	18	21	4700	25
800812	810812	M12	8	162	113	80	19	24	5100	28
800814	810814	M14	8	171	122	89	19	24	5600	31
800816	810816	M16	8	182	133	100	19	24	5600	40
801016	811016	M16	10	190	139	100	24	27	8300	48
801220	811220	M20	12	227	159	120	27	32	12000	79
801422	811422	M22	14	264	191	140	30	36	17000	124
801624	811624	M24	16	308	227	170	32	41	21000	175

Note: All break loads are determined by wedges (jaws) and thread

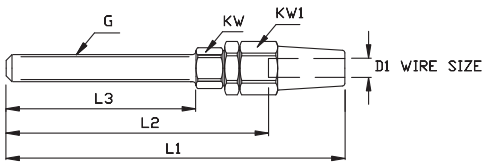

Safe, reliable and machine free swaging of wire with the fastest swageless system on the market. The threaded swageless terminal is easy to use and ideal for site work where a professional swaging would normally be required. The swageless thread terminal is Lloyd's approved and also available with UNF thread on request. See instructions page 14.



## SWAGELESS THREAD TERMINAL WITH CONE

Stainless steel - AISI 316

ART. NO.	WIRE	THREAD	KW1	KW2	L1	L2	BL/KG	KG/100
SC801624	16 - 5/8"	M24	42	32	318	170	21000	198,4
SC801927	19 - 3/4"	M27	44	34	344	180	23000	256,8
SC802230	22 - 7/8"	M30	50	41	392	200	28000	367,8
SC802636	26 - 1"	M36	66	50	446	220	41000	698,2

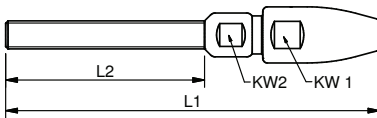

In addition to the Lloyd's approved swageless system, the swageless cone terminal for 1x19 wire construction enables safe and reliable wire attachment up till Ø 26 mm diameter. See instructions page 15.



## DIY TERMINAL

Stainless steel - AISI 316

ART. NO	G	WIRE	D1	L1	L2	L3	L4	BL/KG	KG/100
A640305	M5	3	11	53	8	36	34	300	3,4
A640406	M6	4	13	58	9	38	37	400	5,4
A640406L	M6	4	13	58	20	38	50	400	7
A640506	M6	5	14	65	9	45	37	500	6,4
A640608	M8	6	16	73	12	47	45	600	10,7

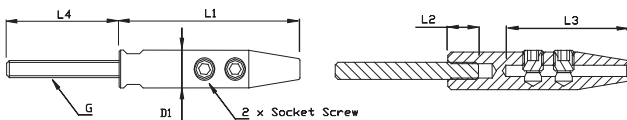

The Do It Yourself terminal is a simple alternative to the swageless terminals as it is fixed to the wire only by use of "allen-headed" screws. Break loads are, therefore, lower than average. The terminals are delivered with external right handed thread stud only, but as this can be removed, they can be combined with the rest of the WDS program and thus offer a wide range of possible DIY solutions. The fittings can be reused and are as such a good solution for private use.

The DIY terminal has inside thread - delivered with removable thread pin!



## THREAD FORKS WELDED

Polished stainless steel - AISI 316

NO. RIGHT	NO. LEFT	G	PIN	A	B	L1	L2	BL/KG	KG/100	PACK
021205B	031205B	M5	5	7,5	12	60	41	800	1,9	10
021206B	031206B	M6	5	7,5	12	67	47	1000	2,3	10
021206XB	031206XB	M6	6	9,5	13	68	47	1200	2,8	10
021208B	031208B	M8	6	9,5	13	79	57	1600	3,9	10
021208XB	031208XB	M8	8	11	15	82	57	2200	5,5	10
021210B	031210B	M10	8	11	15	90	63	3200	6,9	10
021210XB	031210XB	M10	10	12	19	94	63	3400	7,8	10
021212B	031212B	M12	12	14	25	119	80	5000	17	5
021212XB	031212XB	M12	14	18	33	129	80	5000	26,3	5
021214B	031214B	M14	12	14	25	137	90	6900	30,1	5
021216B	031216B	M16	14	18	33	151	100	9400	36,9	5
021216LB	031216LB	M16	14	22	30	149	100	9400	36,9	5
021216XB	031216XB	M16	16	17	32	150	98	9400	39,4	5
021220B	031220B	M20	19	24	48	191	120	14000	71,9	BULK
021220LB	031220LB	M20	19	30	47	190	120	14000	71,9	BULK
021222B	031222B	M22	22	30	57,5	224	140	18200	120,1	BULK
021224B	031224B	M24	25	30	62,5	258	170	21000	180	BULK
021227B	031227B	M27	28	32	68	311	180	23000	215,1	BULK
021230B	031230B	M30	32	35	76	344	200	28000	301,9	BULK
021236B	031236B	M36	35	40	86	385	220	41000	451,7	BULK

All break loads are determined by clevis pin and thread

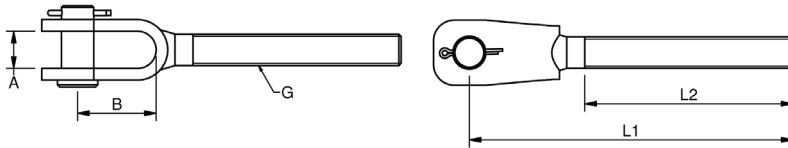

Welded forks with thread and pin for rigging screws, inside thread parts or other terminations. Available with left handed and right handed thread - also UNF sizes on request.

## THREAD FORKS - MACHINED

Polished stainless steel - AISI 316

NO. RIGHT	NO. LEFT	G	PIN	A	B	L1	L2	BL/KG	KG/100	PACK
027420B	037420B	M20	19	20	45	219	125	12000	125	BULK
027422B	037422B	M22	22	22	49	216	140	15000	300	BULK
027424B	037424B	M24	25	25	52	255	170	18000	400	BULK
027427B	037427B	M27	28	30	55	274	180	23000	640	BULK
027430B	037430B	M30	32	35	67	316	200	28000	980	BULK
027436B	037436B	M36	35	35	67	334	220	41000	1300	BULK
027442B	037442B	M42	40	34	75	388	250	70000	805	BULK
M02744648B	M03744648B	M48	46	43	106	459	280	70000	1248	BULK
M02745352B	M03745352B	M52	53	46	122	512	310	80000	1755	BULK
M02745356B	M03745356B	M56	53	46	122	528	330	90000	1873	BULK
M02746060B	M03746060B	M60	60	54	132	574	350	115000	2556	BULK

All break loads are determined by clevis pin and thread

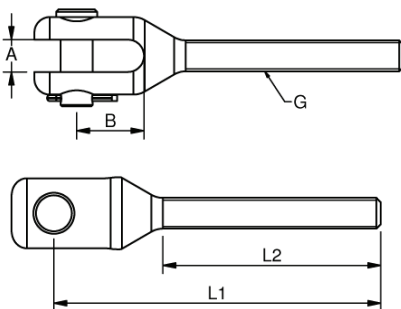

Larger machined forks with thread and pin for rigging screws, inside thread parts or other terminations. Available with left handed and right handed threads - also UNF sizes on request.

From M48 and up forks are supplied with countersunk and double headed pins.



## THREAD FORK - MACHINED - SMALL

Stainless steel - AISI 316

NO. RIGHT	NO. LEFT	G	PIN	A	B	D	L1	L2	BL/KG	KG/100
A421205	A431205	M5	5	5,5	12	11	49	31	400	1,5
A421206	A431206	M6	5	6,5	15	13	58	36	800	2,3
A421208	A431208	M8	6	8,5	19	16	69	42	1200	4,2

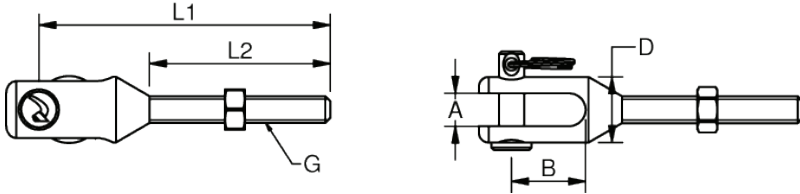

Small machined forks with thread and pin for the small rigging screws, inside thread parts or other terminations. Available with left handed and right handed threads, incl. locking nut.

## THREAD FORK WELDED - SMALL

Stainless steel - AISI 316

NO. RIGHT	NO. LEFT	G	PIN	A	B	L1	L2	BL/KG	KG/100
A320503	A330503	M5	5	7,5	12	49	30	800	1,4
A320604	A330604	M6	5	7,5	12	54	35	1000	2
A320605	A330605	M6	6	9,5	13	56	35	1200	2,5
A320806	A330806	M8	8	11	15	65	40	2200	3,5
A320808	A330808	M10	8	11	15	72	45	3200	6,4
A321010	A331010	M12	9,5	12,5	19	82	50	3600	11

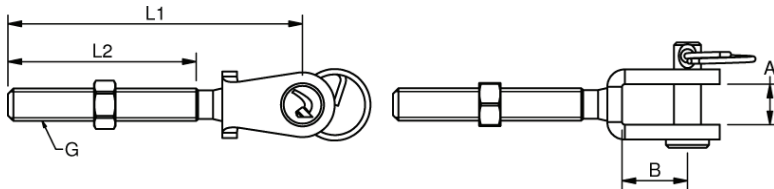

Small welded forks with thread and pin for the small rigging screw bodies, inside thread parts or other terminations. Available with left handed and right handed threads, incl. locking nut.



COPYRIGHT "THE NOMAD CONCEPT"  
WWW.NOMADCONCEPT.COM

## THREAD EYES

Polished stainless steel - AISI 316

ART. NO. RIGHT	ART. NO. LEFT	G	A	D1	D2	L1	L2	BL/KG	KG/100	PACK
021905	031905	M5	3	5,5	12	63	41	800	0,9	25
021906	031906	M6	4	6,5	14	65	47	1200	1,5	25
021908	031908	M8	5	8,5	17	78	57	2200	3,1	25
021910	031910	M10	6	10,5	22	90	63	3500	5,1	25
021912	031912	M12	8	13	25	110	80	5100	10,1	10
021914	031914	M14	9	13	28	124	90	6800	14,1	10
021916	031916	M16	10	14,5	31	133	100	9400	20,4	10
021920	031920	M20	15	19,5	40	164	120	14700	40,6	5
021922X	031922X	M22	18	23	46	196	140	15200	69	BULK
021924X	031924X	M24	20	26	53	230	170	17700	105	BULK
021927X	031927X	M27	25	28,5	65	247	180	23000	153	BULK
021930X	031930X	M30	30	33	70	274	200	28000	204	BULK
021936X	031936X	M36	30	36	80	295	220	41000	296	BULK

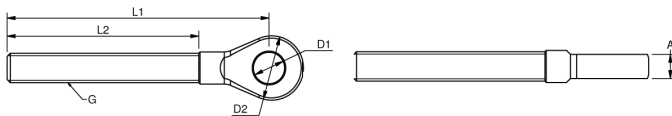

Thread eyes are used in rigging screws, inside thread parts or other similar terminations. Available with left handed and right handed threads - also UNF sizes on request.

## THREAD EYES - SMALL

Stainless steel - AISI 316

NO. RIGHT	G	A	D1	D2	L1	L2	L3	L4	BL/KG	KG/100
A440505	M5	2,5	5,5	9	41	30	11	6	400 kg	0,6
A440506	M6	3,8	5,5	11	48	35	13	7	800 kg	1,3
A440606	M6	3,8	6,5	11	48	35	13	7	800 kg	1,1
A440608	M8	4,5	6,5	15	57	40	16	8,5	1300 kg	2,2

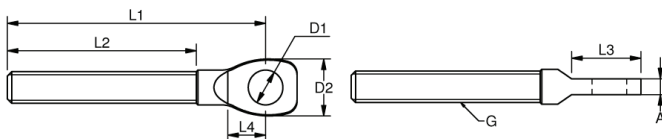

Small thread eyes for use with the small rigging screws body, inside thread parts or other terminations.

## THREAD EYE

Stainless steel - AISI 316

ART. NO.	G	A	D1	D2	L1	L2	BL/KG	KG/100
02190898	M8	9	8	18	30	21	2200	1,9

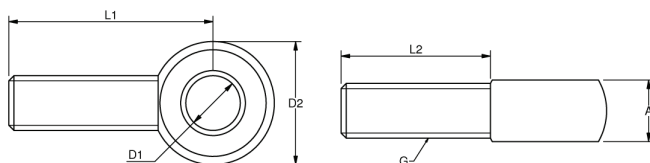

Small thread eyes for use with the small rigging screws body, inside thread parts or other terminations.





## THREADED TOGGLE

Polished stainless steel - AISI 316

NO. RIGHT	NO. LEFT	G	PIN	A	B	C	T	L1	L2	L3	BL/KG	KG/100
023206B	033206B	M6	6	8	17	8	3	88	47	14	1200	5
023208B	033208B	M8	8	10	25	9	3	105	57	18	2200	8,3
023210B	033210B	M10	9,5	12	27	12	4	128	63	22	3500	15,4
023212XB	033212XB	M12	12,7	18	33	18	4	154	80	30	5100	30,5
023214B	033214B	M14	12,7	18	33	18	4	172	90	30	6900	33,3
023216XB	033216XB	M16	16	20	41	20	6	199	100	35	9400	63
023220XB	033220XB	M20	19	24	43	25	8	228	120	40	14700	111

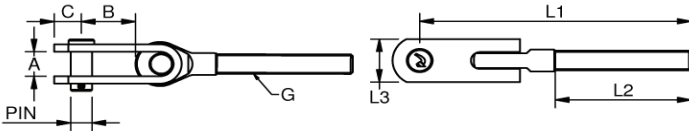

Use the threaded toggles to terminate a rigging screw or other attachment where flexible angles are required or there is a risk of failure due to sideways articulation fatigue e.g. with outdoor canopies etc. Available with left handed and right handed threads - also UNF sizes on request.

## THREADED WALL TOGGLE

Polished stainless steel - AISI 316

NO. LEFT	G	D1	L1	L2	L3	L4	BL/KG	KG/100
03151406	M6	6,4	81	47	40	14	1200	3,8

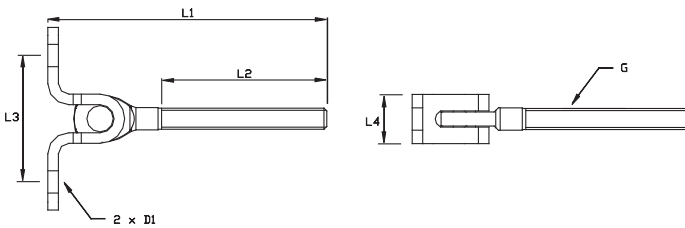

Wall toggle with left handed thread and pin for rigging screws, inside thread parts or terminations to flat surfaces.

## DROPNOSE THREADED - SMALL

Polished stainless steel - AISI 316

NO. RIGHT	NO. LEFT	G	D	D2	L1	L2	L3	L4	BL/KG	KG/100	PACK
A3264M6	A3364M6	M6	9	9,5	55	35	25	47	600	1,9	BULK
A3264M8	A3364M8	M8	9	9,5	60	40	25	52	600	2,7	BULK

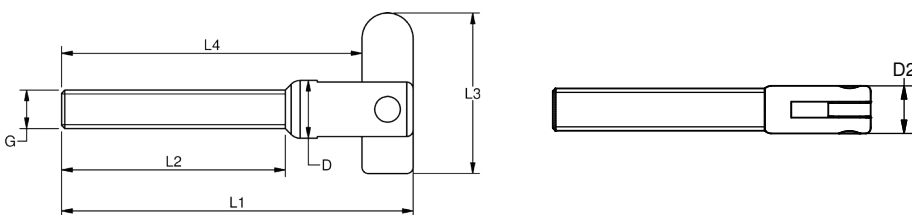

The dropnose is used with the small stainless steel bodies. Also available as terminal for 4 mm and 5 mm wire.

## THREAD PIN

Polished stainless steel - AISI 316

ART. NO.	G	L	KG/100
A400503	M5	38	1
A830570	M5	70	0,8
A400604	M6	45	1
A830670	M6	70	1,2
A400806	M8	52	2

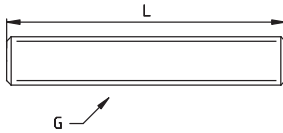

The threaded pins are a useful way to solve a problem where the wire may need to be lengthened... connect it to an inside thread wall anchor and use an inside thread terminal or rigging screw body for tensioning.

## DOUBLE THREADED PIN

Polished stainless steel - AISI 316

ART. NO.	G	L	L1	KW	KG/100	PACK
A392405	M5	60	24	3	0,7	BULK
900305HV	M5	70	30	3	0,95	BULK
A392706	M6	66	27	4	1,2	BULK
900406HV	M6	106	48	4,5	1,91	BULK
A393008	M8	75	30	6	2,3	BULK
900408HV	M8	129	57	6	4,13	BULK
900610HV	M10	145	63	7	7,11	BULK
900712HV	M12	180	80	9	12,96	BULK
900814HV	M14	198	89	11	19,6	BULK

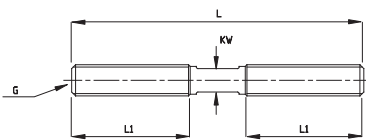

The opposite rigging screw would be a combination of the double threaded pin and inside threaded terminals locked at either side. This is usually used where extra adjustment lengths are needed or when pre-fitted wires are manufactured too short.

## STOP END NUT

Polished stainless steel - AISI 316

ART.NO.	G	D1	D2	L1	L2	BL/KG	KG/100
A160503	M5	8	12	33	30	800	0,8
A160604	M6	8	12	39	35	1300	0,85
A160806	M8	10	14	45	40	2350	1,2
A161008	M10	13	17	50	45	3500	2,5

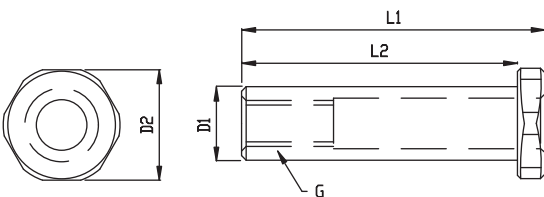

## BODIES

Polished stainless steel - AISI 316

ART. NO.	G	D1	L1	KW	BL/KG	KG/100
011205	M5	8	80	0	800	1,2
011206	M6	10	92	0	1200	2,6
011208	M8	14	112	0	2200	6
011210	M10	17	120	0	3500	9,4
011212	M12	21	150	0	5100	16
011214	M14	21	170	0	6900	18,4
011216	M16	27	190	0	9400	27,2
011220	M20	34	220	0	14000	46,8
011222	M22	40	270	0	18000	120
011224	M24	42	320	0	21000	147,5
011227	M27	55	345	0	23000	210
011230	M30	55	380	0	28000	309
! 012320	M20	40	240	36	14000	158,2
! 012322	M22	40	270	41	18000	161,6
! 012324	M24	50	325	46	21000	312,6
! 012327	M27	55	345	50	23000	408,1
! 012330	M30	60	375	55	28000	538,4
! 012336	M36	65	410	60	41000	602,8
! 012342	M42	69	440	64	70000	774
! 012348	M48	74	490	68	90000	922,8
! 012352	M52	79	540	72	110000	1141,5

! Body with bronze inserts

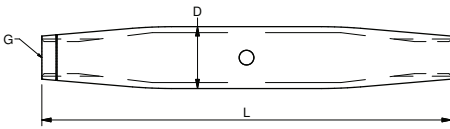

Blue Wave rigging screws bodies feature thread size, "easy use" marking for left and right threaded side and adjustment hole. From M20 upwards the bodies are available with chrome bronze threaded inserts and spanner flat on body for smooth adjustment.

## BODIES - SMALL

Polished stainless steel - AISI 316

ART. NO.	G	D	L	BL/KG	KG/100
A011205	M5	8	60	800	0,9
A011206	M6	10	65	1200	1,7
A011208	M8	14	80	2200	4,3
A011210	M10	17	90	3500	7
A011212	M12	23	120	5100	11,3

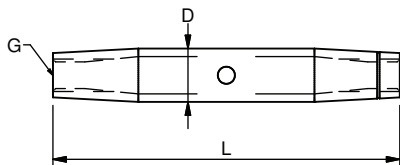

In order to match the small WDS fittings, the small bodies have less adjustment but also feature thread size and, "easy use" marking for left and right threaded side and adjustment hole.

## INSIDE THREAD TERMINAL - SMALL

Polished stainless steel - AISI 316

NO. RIGHT	NO. LEFT	G	WIRE	D1	D2	D3	L1	L2	L3	L4	BL/KG	KG/100	
A140503	A150503	M5	3	1/8"	7,13	5,5	3,5	65	25	20	35	360	1,2
A140604	A150604	M6	4	5/32"	8	6,35	4,4	65	25	20	35	640	1,7
A140605	A150605	M6	5	3/16"	8	7,5	5,3	70	30	20	30	1000	2,6
A140806	A150806	M8	6	-	11	9,0	6,5	85	40	25	40	1400	6,3

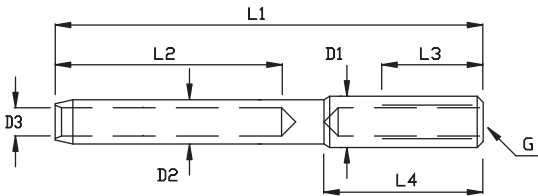

The small inside thread terminals are for lighter architectural fixing of wires. The terminals are available with left handed and right handed threads, with dimensions reduced to a minimum. These terminals are suitable for hand crimping with Blue Wave Arctool ACC1 & Arctool8, see page 78+79.



## INSIDE THREAD FORK WELDED - SMALL

Polished stainless steel - AISI 316

ART. NO.	NO. LEFT	G	WIRE	PIN	A	B	D	L1	L2	BL/KG	KG/100
A340503	A350503	M5	3	5	7,5	12	7,1	59	25	800	1,4
A340504	A350504	M6	4	5	7,5	12	8	67	30	1000	1,9
A340605	A350605	M6	5	6	9,5	13	8	68	30	1300	2,2
A340806	A350806	M8	6	8	11	15	11	79	35	2350	4,5

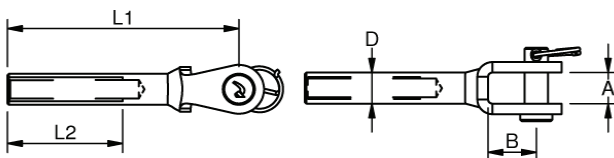

For small architectural wires another good alternative to rigging screw adjustment is the inside thread forks. The forks have a light design as dimensions are reduced to a minimum - the forks are available with left handed and right handed threads as well as in a welded and machined version.

## INSIDE THREAD DOMEHEAD

Polished stainless steel - AISI 316

ART. NO.	G	D1	D2	L1	L2	L3	BL/KG	KG/100
A170503	M5	7,13	10	43	40	25	800	0,5
A170604	M6	8	11,5	49	45	30	1300	0,7
A170806	M8	11	14	60	55	35	2350	1,0

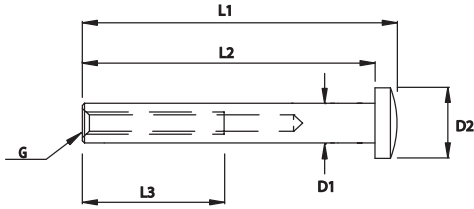

The inside thread dome head is, when combined with a threaded terminal, an ideal end/adjustment fitting for balustrades with through going holes. For 4 mm wire it can also be combined with a ball for dome head terminal, for diagonal or angle tensioning. The dome head features an Allen key hole and minimum overall dimensions.

## INSIDE THREAD TERMINALS

Polished stainless steel - AISI 316

NO. RIGHT	NO. LEFT	G	WIRE	A	D1	D2	L1	L2	L3	L4	BL/KG	KG/100	PACK
982504	ON REQUEST	M4	2,5	2,8	5,5	5,5	59	27	15	25	500	0,8	BULK
980305	ON REQUEST	M5	3	3,5	6,35	7,13	77	38	20	30	800	1,3	BULK
980305L	ON REQUEST	M5	3	3,5	6,35	7,13	92	38	35	45	800	1,6	BULK
980406	ON REQUEST	M6	4	4,4	7,5	8	84	45	20	30	1250	1,8	BULK
980406L	ON REQUEST	M6	4	4,4	7,5	8	99	45	35	45	1250	2,1	BULK
980506	ON REQUEST	M6	5	5,3	9	9	90	51	20	30	1250	2,8	BULK
980506L	ON REQUEST	M6	5	5,3	9	9	105	51	35	45	1250	3,2	BULK
980508	ON REQUEST	M8	5	5,3	9	12,58	112	51	40	53	2350	5,4	BULK
980608	ON REQUEST	M8	6	6,5	12,58	12,58	110	64	25	35	2350	7,2	BULK
980608L	ON REQUEST	M8	6	6,5	12,58	12,58	126	64	40	50	2350	8,2	BULK
980610	ON REQUEST	M10	6	6,5	12,58	16	127	64	40	53	3500	10,5	BULK
980810	ON REQUEST	M10	8	8,4	16	16	140	83	40	50	3500	15,4	BULK
980812	ON REQUEST	M12	8	8,4	16	18	147	83	40	53	5100	16,7	BULK
981012	ON REQUEST	M12	10	10,5	17,8	17,8	150	89	40	50	5100	19,4	BULK
981016	ON REQUEST	M16	10	10,5	17,8	22	152	89	40	53	8000	20,7	BULK

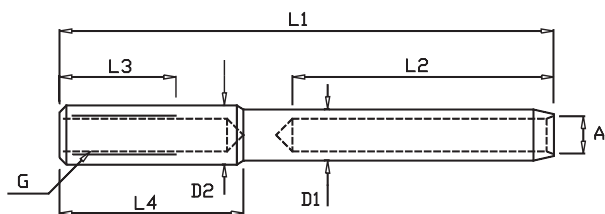

Often found to be a good alternative to a standard rigging screw. The terminals are available with right handed threads and left handed on request. For ease of use when pressing or swaging onto the wire, the terminals are marked with wire size and swage depth.



## SWAGELESS TERMINALS - SMALL

Polished stainless steel - AISI 316

ART.NO	G RIGHT	WIRE	D	L1	L2	KW1	KW2	BL/KG	KG/100
A833205	M5	1/8"	11	45	20	9	8	300	2,8
A830406	M6	4 5/32"	11	45	20	9	8	400	2,8

Note: Only for use with wire ropes 7 x 19 and 7 x 7

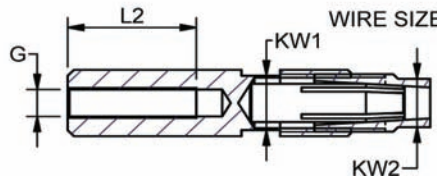
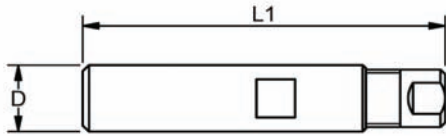

Small swageless terminal for soft wire ropes. Inside thread RH makes various attachments possible.



## SWAGELESS FORK TERMINAL - SMALL

Polished stainless steel - AISI 316

ART. NO.	WIRE	PIN	G	A	B	D	KW1	KW2	L1	BL/KG	KG/100	PACK
A840406	4	5	M6	7,5	12,2	11	9	8	77	400	4,6	BULK

Note: Only for use with wire ropes: 7 x 19 and 7 x 7

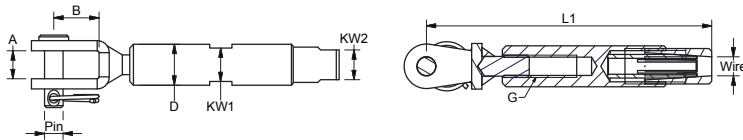

The small swageless terminal for soft wire ropes fitted with fork/Ø5 mm pin. No adjustment possible.



## SWAGELESS - TERMINALS - SMALL

Polished stainless steel - AISI 316

NO.RIGHT	NO.LEFT	WIRE	G	D	KW1	KW2	L1	L2	BL/KG	KG/100	PACK
A860306	A870306	3	M6	11	8	9	61	25	300	3,1	BULK
A860406	A870406	4	M6	13	9	11	66	25	400	4,7	BULK
A860506	A870506	5	M6	15	10	12	70	25	500	6,5	BULK
A860608	A870608	6	M8	16	12	14	86	30	600	8,8	BULK

Note: Only for use with wire ropes: 7 x 19 and 7 x 7

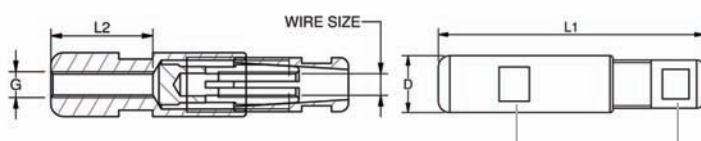

KW2 KW1



The small swageless terminal for soft wire ropes with inside thread RH as well as LH.



## DOMEHEAD TERMINALS

Polished stainless steel - AISI 316

ART. NO.	WIRE	D1	D2	D3	L1	L2	L3	KG/100	PACK
660003	3 1/8"	6,35	10	3,5	52	48,5	38	1,1	20
660004	4 5/32"	7,5	11,5	4,4	59	55,5	45	2,4	20
660005	5 3/16"	9	14	5,3	66,5	62,5	51	3,8	20
660006	6 -	12,58	18	6,5	79	74	64	7,9	20

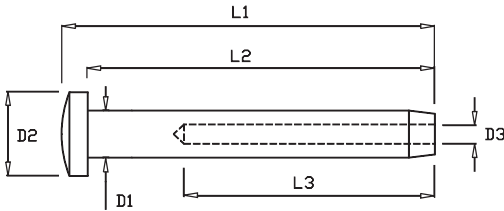

Domehead terminals by Blue Wave are engraved with wire size and swage depth marking, thereby making them easier to work with and to press or swage onto the wire.



## BALL TERMINAL

Polished stainless steel - AISI 316

ART. NO.	WIRE	D1	D2	L1	L2	L3	L4	KG/100	PACK
620003	3 -	3,5	6,35	58	54	38	13	1,1	20
620032	- 1/8"	3,5	6,35	58	54	38	13	1,1	20
620004	4 5/32"	4,4	7,5	69	63	45	16	2,4	20
620005	5 3/16"	5,3	9	79	72	51	19	3,8	20
620006	6 -	6,5	12,58	90	84	64	20	7,9	20
620007	7 9/32"	7,5	14,2	94	87	70	21,3	10	20
620008	8 5/16"	8,4	16	116	108	83	26,3	16,9	10
620010	10 -	10,5	17,8	129	119	89	27,5	23,5	10
620012	12 -	12,5	20	145	135	105	28	26,7	5

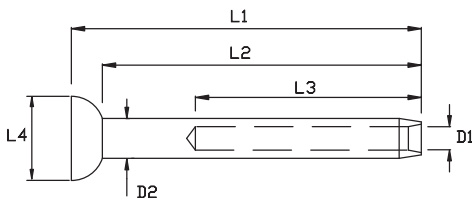

Blue Wave's ball terminals are marked with wire size and wire-hole depth to make it easier to work with and press or swage onto the wire.

More ball terminals available in the marine product range.



## DOMEHEAD TERMINAL - SMALL

Polished stainless steel - AISI 316

ART. NO.	WIRE	D1	D2	D3	L1	L2	L3	BL/KG	KG/100
A100003	3 1/8"	5,5	8	3,5	35	25	32	360	0,5
A100004	4 5/32"	6,35	10	4,4	35	25	32	640	0,7
A100005	5 3/16"	7,5	12	5,3	41	30	37	1000	1
A100006	6 -	9	14	6,5	52	40	47	1400	1,9

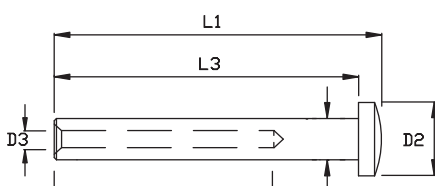

The small domehead terminals are for lighter architectural fixing of wires. The focus of the design is the size. Overall dimensions have thus been reduced to a minimum, leaving markings out. The small fittings are suitable for hand crimping with Blue Wave Arctool ACC1 & Arctool8.



## DROPNOSE TERMINAL - SMALL

Polished stainless steel - AISI 316

ART. NO	WIRE	D1	D2	D3	L1	L2	L3	L4	BL/KG	KG/100
A640004	4	6,3	4,4	7,6	52	22	32	45	300	1
A640005	5	7,5	5,3	8,4	52	22	32	45	400	1,3

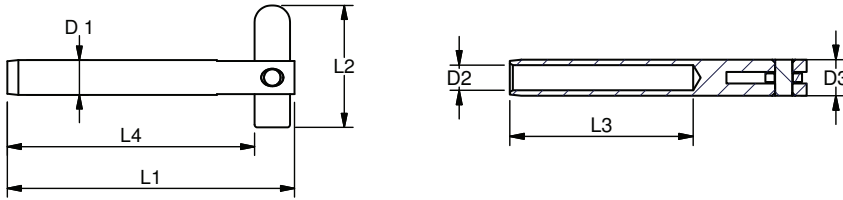

The dropnose terminal is e.g. perfect for tube handrails with vertical wire suspensions. Almost the easiest mounting imaginable - after being attached to the wire, drill a hole and stick through the drop nose end of the terminal and let it drop. Also available with thread.



## CONE TERMINALS - SMALL

Polished stainless steel - AISI 316

ART.NO.	WIRE	D	D2	D3	L1	L2	L3	BL/KG	KG/100	
A110003	3	1/8"	3,5	5,5	8	35	25	32,5	360	0,5
A110004	4	5/32"	4,4	6,35	10	35	25	32	640	0,7
A110005	5	3/16"	5,3	7,5	12	41	30	38	1000	1
A110006	6	-	6,5	9	14	52	40	48,5	1400	1,9

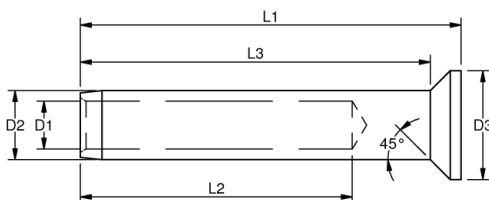

The small cone terminals are for lighter architectural fixing of wires. The focus of the design is the size. Overall dimensions have thus been reduced to a minimum, leaving markings out.

The small fittings are suitable for hand crimping with Blue Wave Arctool ACC1 & Arctool 8.



Angle hinge for cone terminals page 53.





## ANGLE HINGE

Polished stainless steel - AISI 316

ART. NO.	$\alpha$	L	D1	D2	KG/100	PACK
A302003	20	5	11	5	0,4	10
A302503	25	5	11	5	0,4	10
A303003	30	5	11	5	0,5	10
A303503	35	5	11	5	0,6	10
A304003	40	5	11	5	0,6	10
A302004	20	5	13	6	0,6	10
A302504	25	5	13	6	0,7	10
A303004	30	5	13	6	0,8	10
A303504	35	5	13	6	0,8	10
A304004	40	5	13	6	0,9	10
A302006	20	5	17	8,2	1,2	10
A302506	25	5	17	8,2	1,2	10
A303006	30	5	17	8,2	1,3	10
A303506	35	5	17	8,2	1,5	10
A304006	40	5	17	8,2	1,6	10

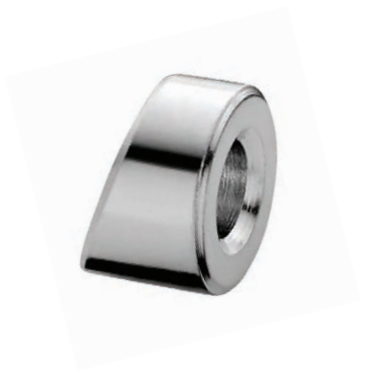
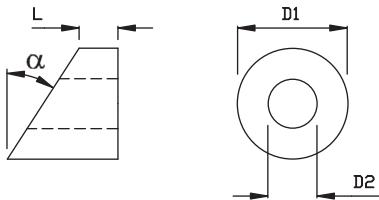

The angle hinges are used for standard threaded or cone terminals and give a nice final attachment to diagonal wire installations or on, for example, staircases.



## ANGLE HINGE FOR CONE TERMINALS

Polished stainless steel - AISI 316

ART. NO.	$\alpha$	L	D1	D2	D3	L1	KG/100	PACK
A312003	20	5	11	6	8,3	1	0,4	10
A312503	25	5	11	6	8,3	1	0,4	10
A313003	30	5	11	6	8,3	1	0,5	10
A313503	35	5	11	6	8,3	1	0,6	10
A314003	40	5	11	6	8,3	1	0,6	10
A312004	20	5	13	7	10,3	1	0,6	10
A312504	25	5	13	7	10,3	1	0,7	10
A313004	30	5	13	7	10	1	0,8	10
A313504	35	5	13	7	10	1	0,8	10
A314004	40	5	13	7	10	1	0,9	10
A312005	20	5	14	8	12	1	0,8	10
A312505	25	5	14	8	12	1	0,9	10
A313005	30	5	14	8	12	1	0,9	10
A313505	35	5	14	8	12	1	1	10
A314005	40	5	14	8	12	1	1,1	10
A312006	20	5	17	10	15	1	1,2	10
A312506	25	5	17	10	15	1	1,2	10
A313006	30	5	17	10	15	1	1,3	10
A313506	35	5	17	10	15	1	1,5	10
A314006	40	5	17	10	15	1	1,6	10

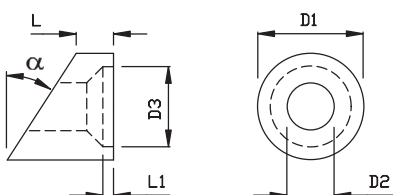

## WDS BALL

Polished stainless steel - AISI 316

ART. NO.	WIRE DIM.	G	D	L	KG/100
A240503	3	M5	15	12	1,9
A240503X	3	M5	20	16	2,9
A240605	4 / 5	M6	20	16	2,9
A240806	6	M8	25	20	5,7

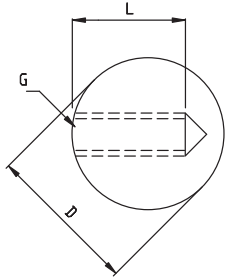

The range of WDS balls are used as stop ends to various wire fittings. Also ideally suited for angled installation of wires.

## BALL FOR DOMEHEAD SCREW

Polished stainless steel - AISI 316

ART. NO.	G	D	D1	KG/100
A270503	M5	15	5,3	1,2
A270604	M6	20	6,3	2,9
A270806	M8	25	8,5	5,7
A271008	M10	30	10,5	8,8

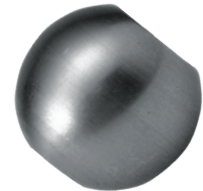
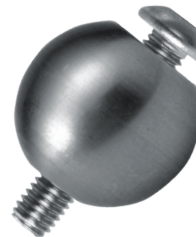
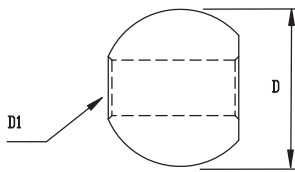

## BALL FOR DOMEHEAD TERMINAL

Polished stainless steel - AISI 316

ART. NO.	WIRE	D	D1	D2	B	KG/100
A280003	3	15	6	8,5	2,3	2,2
A280004	4	20	7	10,5	2,0	2,9
A280005	5	20	8	12,0	2,7	5,7
A280006	6	25	9,5	14,5	3,5	5,7

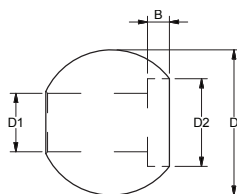

## NET CLIPS

Polished stainless steel - AISI 316

ART. NO.	WIRE	G	D1	L	L1	L2	L3	KG/100
A600003C	3	M10	17	19	5	8	3,2	2,4
A600004C	4	M12	20	21	5	8	4,2	3,6
A600005C	5	M12	20	23	5	10	5,2	3,6
A600006C	6	M12	20	25	5	10	6,2	5,8
A600008C	8	M16	26	32	8	15	8,3	7,7

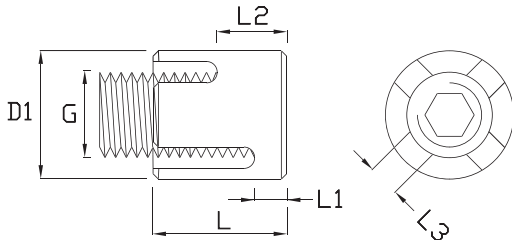

Net clips are used where crossed wires need connection e.g. for wire nets. They are supplied in two versions - one with through-going thread and one without.

### For through - wire going thread please order

ART. NO.	WIRE	G	D1	L	L1	L2	L3	KG/100
A610003C	3	M10	17	19	5	8	3,2	2,4
A610004C	4	M12	20	21	5	8	4,2	3,6
A610005C	5	M12	20	23	5	10	5,2	3,6
A610006C	6	M12	20	25	5	10	6,2	5,8
A610008C	8	M16	26	32	8	15	8,3	7,7

## FLEXIBLE NET CLIP

Polished stainless steel - AISI 316

ART.NO.	G	Ø	D	L	ROTATION	KG/100
A602403	M12	3	20	17,5	0-90 Dg.	31
A602404	M12	4	20	19,5	0-90 Dg.	32
A602405	M12	5	20	21,5	0-90 Dg.	32
A602406	M12	6	20	23,5	0-90 Dg.	34

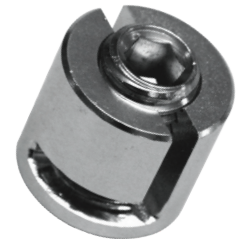
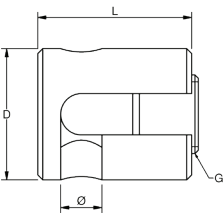

With the flexible net clip two crossing wires can be fixed in angle from 0-90 degrees.

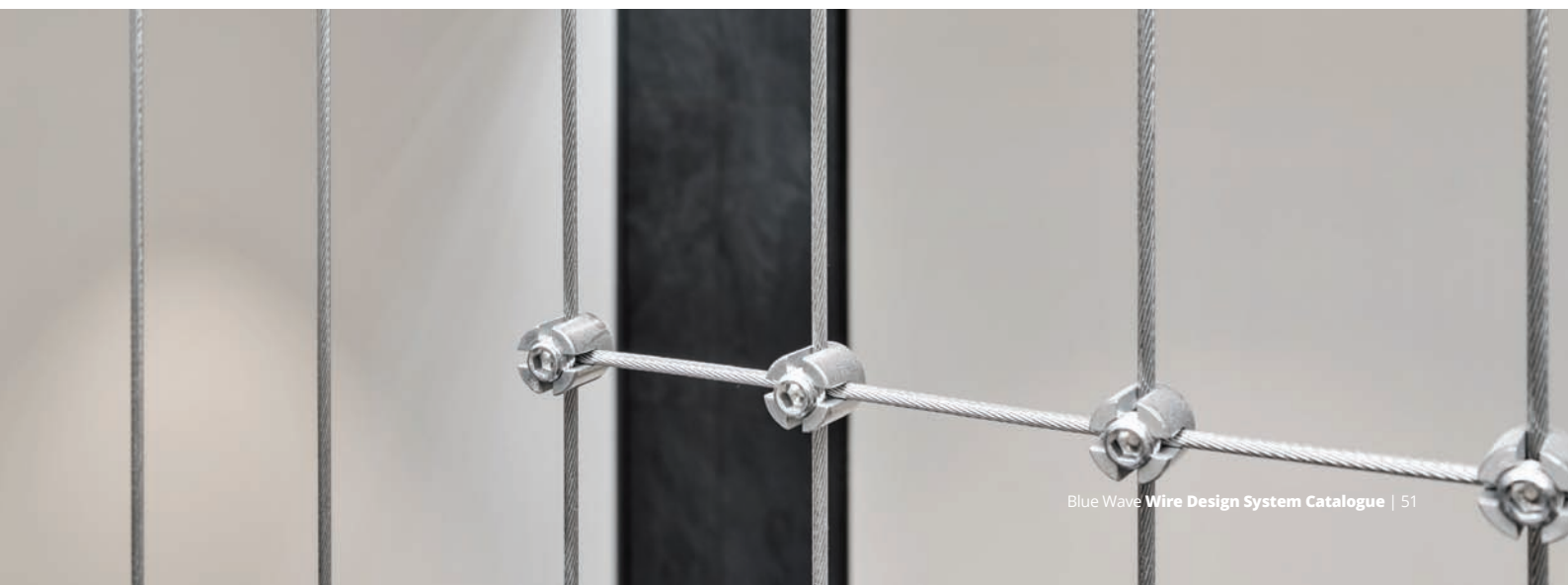

## WIRE ROPE CLIPS

Stainless steel - AISI 316

ART. NO.	SIZE	G	A	L1	L2	L3	L4	GRIPS PER LOOP	KG/100
A580303	3mm	M3	7	19	10	17,7	11	3	1
A580404	4mm	M4	9	21	10,7	21	12,7	3	1,5
A580505	5mm	M5	12	28	13	25	14	4	2,6
A580606	6mm	M6	16	32	15,5	28	15,8	4	3,6
A580808	8mm	M6	16	36	16,5	36	18,5	4	4,8

Note: Only for wire ropes

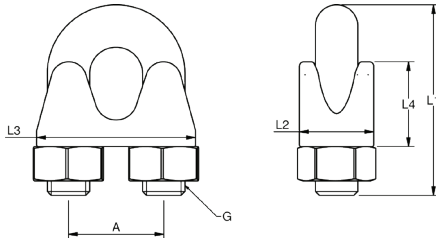

Clamps are used for making wire loops with or without thimbles on site.



## CLAMPS DUPLEX

Stainless steel - AISI 316

ART. NO.	WIRE	G	L1	L2	KG/100
A570403	3	M4	35	14	1,41
A570504	4	M5	40	17	2,45
A570505	5	M5	50	21	2,91
A570606	6	M6	60	25	5

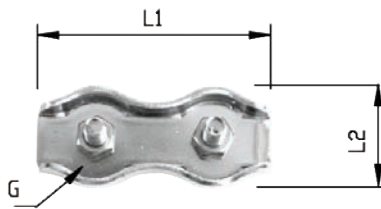

## CLAMPS SIMPLEX

Stainless steel - AISI 316

ART. NO.	WIRE	G	L1	L2	KG/100
A560403	3	M4	17	14	0,72
A560504	4	M5	20	17	1,27
A560505	5	M5	25	21	1,46
A560606	6	M6	30	25	2,52

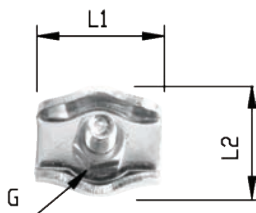

## COVER DISK

Polished stainless steel - AISI 316

ART. NO.	D1	D2	D3	KG/100
A500003	15	5,5	3	0,35
A500004	20	6,5	4	0,85
A500006	25	8,5	4	1,3

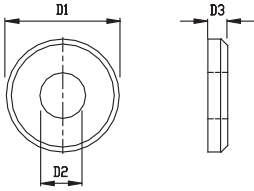

The final touch to an installation may be given by use of a cover disk. The WDS cover disk is "heavy" machined and has a raised edge .

## BALUSTRADE WIRE RELIEF

Nylon

ART. NO.	D1	D2	D3	L1	L2	HOLE SIZE	KG/100	PACK
A6504	4,2	13	9,2	11,2	8	9	0,1	100
A6505	5,7	14	10,2	13,1	10	10	0,13	100
A6506	6,4	14	10,2	13,1	10	10	0,12	100
A6508	8,4	15,6	13,2	13,1	10	13	0,14	100

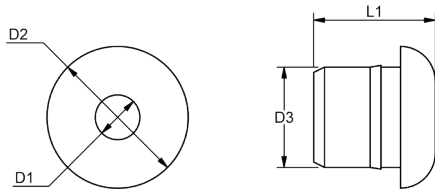

**Black split bushing for push or glue in**



The wire reliefs are used e.g. to avoid direct contact between wire and balustrade. Reduce wear and tear and avoid fx galvanic corrosion.



## STOPPER

Polished stainless steel - AISI 316

ART. NO.	WIRE	G	B	L	L1	L2	SLIP LOAD	KG/100
A650003	3	M3	10	15	3	2,5	100kg	1,4
A650004	4	M3	10	15	4	3	100kg	1,4
A650005	5	M4	10	20	5	4	100kg	2,1
A650006	6	M3	10	20	6	5	100kg	2,1
A650008	8	M4	12	23	8	7	150kg	2,6

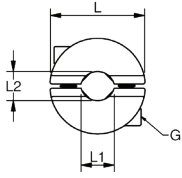

**Inside jaws  
for better grip**



Stoppers are used on both horizontal and vertical wires. They come in two parts for easy installation; have small teeth inside and thus a better grip when load is applied.

## STOPPER

Polished stainless steel - AISI 316

ART. NO.	WIRE	G	L	D	KG/100
A660003	3 - 4	M8	12	15	13
A660005	5 - 6	M10	15	20	30

NOTE: for use on 7 x 19 and 7 x 7 wire only

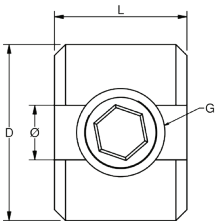

The stoppers can be used on both horizontal balustrades and e.g. as climbing help for vertical trellis wires.

## WIRESTOP

Polished stainless steel - AISI 316

ART. NO.	WIRE	D1	D2	L1	KG/100	PACK
TAL9004	4 - 5/32"	4,4	7,5	8	0,2	20
TAL9005	5	5,3	9	10	0,3	20
TAL9006	6 - 1/4"	6,5	12,6	12	0,9	20
TAL9008	8 - 5/16"	8,5	16	16	1,8	20

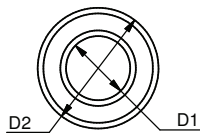
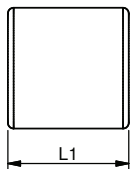

These wire stops have to be pulled on the wire before endfittings are swaged. Afterwards the stoppers can be pressed in the right position on the wire.



## DUAL THREAD SCREW

Polished stainless steel - AISI 316

NO. RIGHT	NO. LEFT	G	D	L1	L2	L3	KG/100
A410503	A420503	M5	5	70	25	40	0,78
A410604	A420604	M6	6	80	35	40	1,32
A410806	A420806	M8	8	86	40	40	2,55

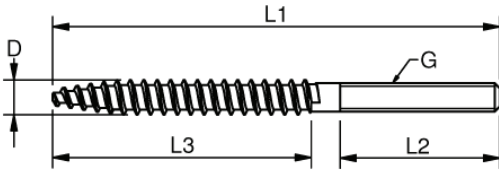

Dual thread screw tong. Page 78



The dual thread pin allows direct installation into wood and if combined with the correct raw plug it is attachable to almost any wall. Ideal for inside thread solutions.

## RAMPA SCREW

Polished stainless steel - AISI 316

NO. RIGHT	NO. LEFT	G	L	D1	D2	KW	KG/100
A410520	A420520	5	20	11	8,5	5	0,6
A410624	A420624	6	24	12	9,5	6	1,1
A410828	A420828	8	28	14	11,5	8	1,6

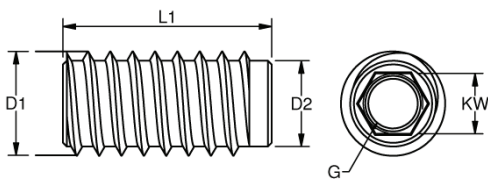

Use with thread terminal and nut.



Rampa screw with inside thread left and right for anchoring into wood. Allows "hidden" adjustment of M5 - M8 threaded parts.

Inside allen key!

## SCREW EYES

Polished stainless steel - AISI 316

ART. NO.	A	D1	D2	L1	L2	L3	KG/100
A433553	3	5,3	5	57	40	12	0,7
A434063	3,8	6,3	6	58	40	13	1

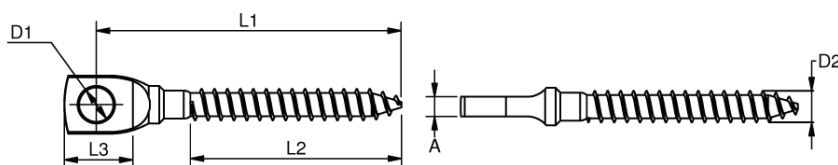

The screw eyes can be directly installed in wood and if combined with the correct raw plug can be attached to almost any wall. Use it as a small eyebolt for attachment to forks, toggle forks, shackles etc.



### **Glass Roof System**

Modern and exclusive designed anchor system for glasroofs - protects entrances against wind and weather.

- Flexible in design - use two or more anchors and customize to individual glass roof size
- Available for canopies with wall distance from 1.000 - 1.400 mm
- 100 % AISI 316 stainless steel
- Mounted with M10 inside thread wall anchors







## GLASS ROOF FITTINGS

Polished stainless steel - AISI 316

Two anchors mounted in a distance of 1.300 mm will allow for a glass canopy up to 1.900 mm long.

Depending on desired glass width, choose system for:

- 1.000 mm wall distance
- 1.200 mm wall distance
- 1.400 mm wall distance

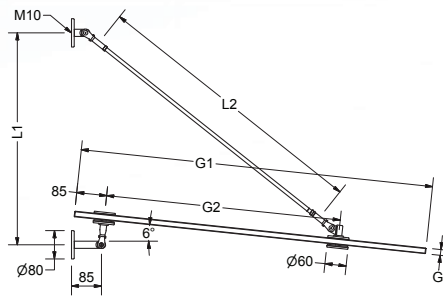
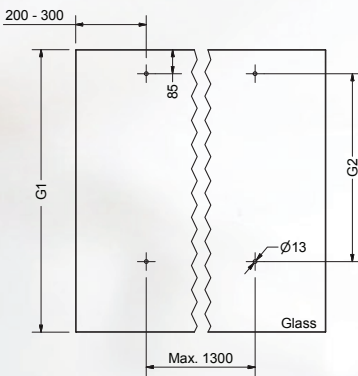

ART. NO.	G1	G2	G	L1	L2	MAX. LOAD PR ANCHOR	WEIGHT 1 LINE
AGLASS1S	1000	665	2x8 = 16	600	800	300 KG	2,061 KG
AGLASS2S	1200	865	2x8 = 16	750	1065	300 KG	2,228 KG
AGLASS3S	1400	1065	2x10 = 20	885	1295	300 KG	2,373 KG



**Shade - and membrane plates**

- AISI 316L stainless steel
- Flexible anchor plates for private and public use
- Suited for webbing and wire suspension
- Plate break loads up to 3.500 kg



**CORNER PLATE FOR WEBBING**

Polished stainless steel - AISI 316L

ART. NO.	BL/KG	KG/100	PACK
SAIL60	1200	21,1	1

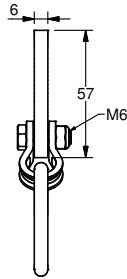
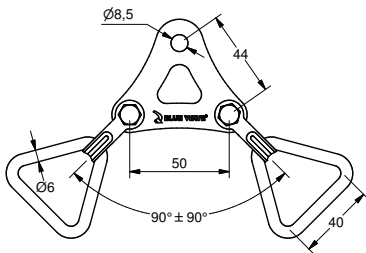

- Attach and tension with Ø 8 mm or 5/16" pin
- Breakload 1200 kg



## CORNER PLATE FOR Ø 6 MM WIRE

Polished stainless steel - AISI 316L

ART. NO.	BL/KG	KG/100	PACK
SAIL130	3500	119	1

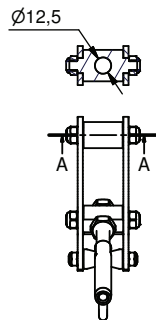
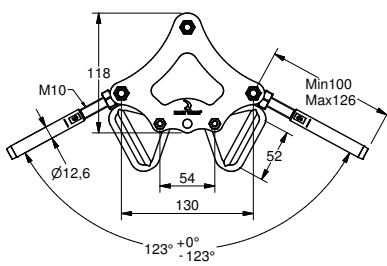

- Attach with M12 or ½" thread, washers and nuts
- On request also available:
  - For ¼" wire size
  - With DIY wire terminals
  - With UNF threaded swage terminals.
- Breakload 3500 kg



**Ball connection for Ø 3, 4 & 5 mm wire railings**

- Imperial wire sizes 1/8", 5/32" & 3/16"
- Elegant and flexible in angle up to 45 degrees
- Easy mounting and tensioning
- Single cable runs up to 9 meters
- Washer for round posts available
- Swagless termination available



## BALL CONNECTION

Polished stainless steel - AISI 316L

ART. NO.	WIRE	G	D1	D2	D3	D4	L1	L2	L3	L4	L5	BL/KG	KG/100	PACK
A290603	3	M6	5,5	20	3	6,3	65	25	20	19	15	360	5,5	10
A290604	4	M6	6,35	20	3	6,3	65	25	20	19	15	500	6	10
A290605	5	M6	7,5	20	3	6,3	70	30	20	19	15	500	6,9	10

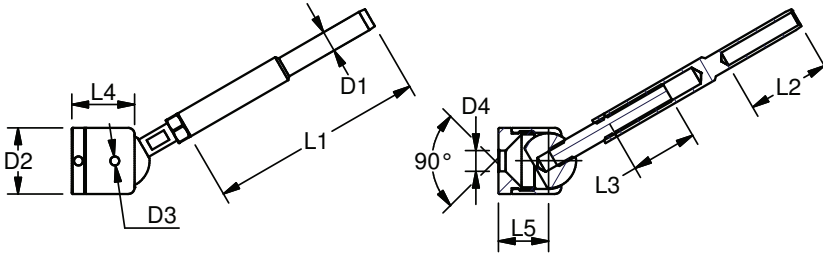

## BALL CONNECTION TERMINAL

Polished stainless steel - AISI 316L

ART. NO.	D1	WIRE	D3	D4	D5	L1	L2	L3	L4	BL/KG	KG/100	PACK
A290603T	5,5	3	6,3	20	3	51	25	26	19	360	3,9	10
A290604T	6,35	4	6,3	20	3	51	25	26	19	500	4	10
A290605T	7,5	5	6,3	20	3	58	30	28	19	500	4,5	10

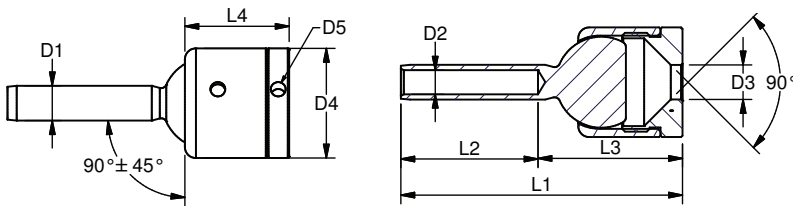

## WASHER

Polished stainless steel - AISI 316L

ART. NO.	D1	D2	L	Ø
A03291506	20	6,3	6	42

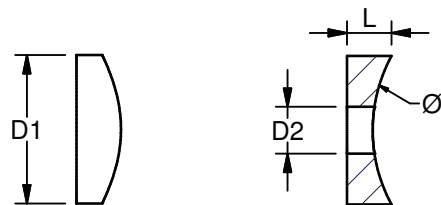

**Green Line System**

As advantages in green walls and trellis systems become known and demand for green urban environments grow, the Green Line system has become popular due to its long lifespan and low maintenance.

Green Line allows for easy and individually designed trellis systems on new as well as existing buildings and facades.

- Assists plants to climb without damaging the structure
- Elegant design and easy mounting
- Flexible design – posts take wire from Ø 4 – Ø 6 mm (5/32"–1/4")
- Posts available with 85 mm and 110 mm wall distance
- Mounts on M8 thread (eg. via inside thread anchor or dual thread screw)
- 100 % AISI 316 stainless steel

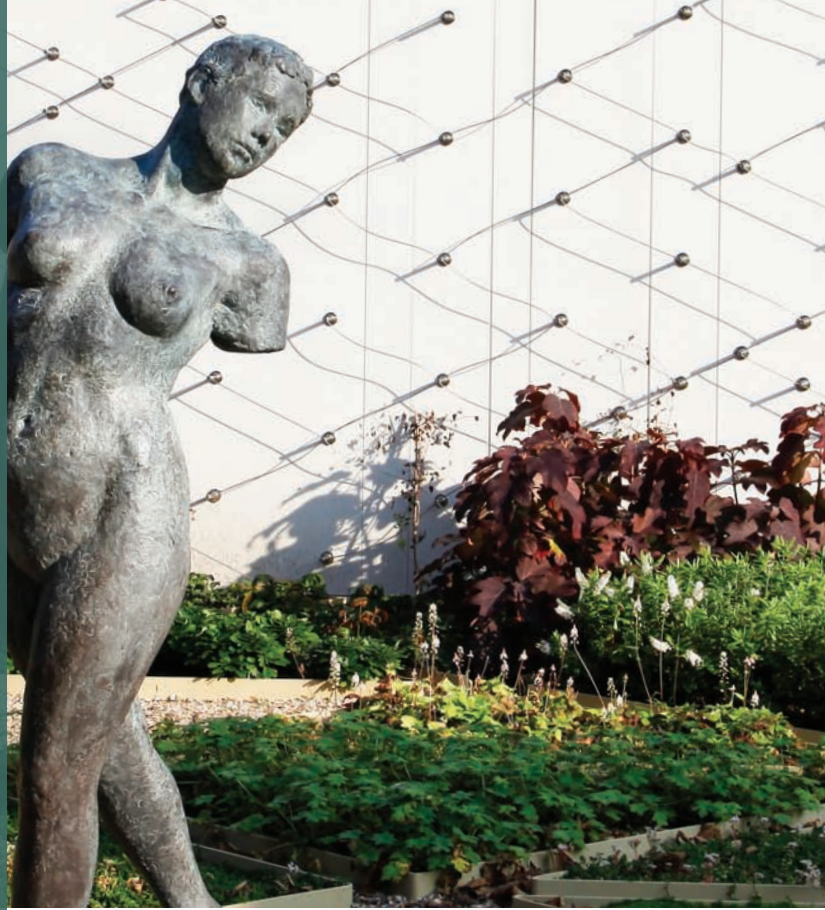

The green line posts individually takes loads up to 100 kg. and should be used with a max distance of one meter.

Add strength to the posts by additional attachment to a top eye.

As plants grow differently and local weather will impact loads applied to a fully grown GREENLINE wall this should always be taken into plan to determine amount of posts needed.



**Suggested  
terminals  
used with  
posts**



## GREEN LINE POST

Polished stainless steel - AISI 316L

ART. NO.	D1	D2	D3	G1	G2	L1	L2	L3	L4	LOAD	KG/100	PACK
GL1	50	16	6,5	M8	M8	94	85	75	30	100kg	23,5	1
GL2	50	16	6,5	M8	M8	119	110	100	30	100kg	27,5	1

Mount on a M8 right hand threaded rod or use dual thread screw A410806

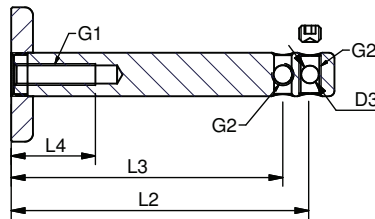
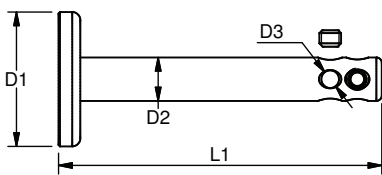

## THREAD TOP EYE

Polished cast stainless steel - AISI 316

ART. NO.	D1	D2	D3	L1	L2	L3	B	BL/KG	KG/100	PACK
A421006	8,5	25	8	62	53	39	7	1200	2,5	10

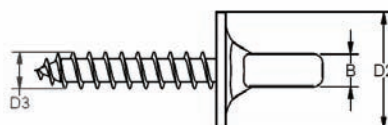
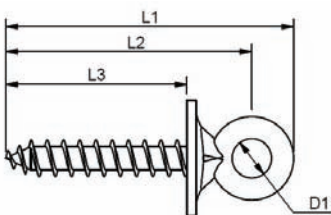







### Vertical Balustrade Kit

Includes 110 mm 7x7 Ø 4 mm wire with one end pressed dropnose terminal for fast attachment and one DIY swageless thread terminal for bottom attachment and tensioning.

- 100 % AISI 316 stainless steel
- 300 kg break load
- DIY system flexible in use for private or field jobs
- Top and bottom Ø 6,5 mm hole size for easy mounting
- Loose fittings available

## VERTICAL BALUSTRADE KIT

Stainless steel - AISI 316

Stainless steel wire with dropnose terminal and threaded DIY terminal for vertical tensioned ballustrades and railing systems.

ART. NO	WIRE	G	BL/KG	KG/100
VBK0406	4 - 5/32"	M6	300	17,6



## EYE BOLTS WELDED

Polished stainless steel - AISI 316

ART. NO.	G	D1	D2	B	L1	L2	L3	L4	BL/KG	KG/100	PACK
370630	M6	13	25	5	57	46	30	30	1200	1,8	10
370640	M6	13	25	5	66	56	40	40	1200	2,8	10
370650	M6	13	25	5	76	62	50	50	1200	3	10
370660	M6	13	25	5	87	76	60	60	1200	2,6	10
370600	M6	13	25	5	126	115	100	95	1200	3,7	10
370835	M8	15	25	6	66	53	35	35	2200	3,8	10
370850	M8	15	25	6	80	68	50	50	2200	4,9	10
370880	M8	15	25	6	110	98	80	75	2200	5,5	10
370800	M8	15	25	6	130	118	100	75	2200	6,5	10
371050	M10	16	30	7	85	70	50	50	3500	8,7	10
371000	M10	16	30	7	135	120	100	95	3500	11	10
371250	M12	18	30	9	90	74	50	45	4500	10,2	10
371210	M12	18	30	9	140	124	100	85	4500	15	10
371216	M12	18	30	9	200	184	160	85	4500	19	10

Note: All break loads are determined by eye (D) and thread



The Welded eye bolts are supplied with a pre-welded cover disc, washer and nut and offer a strong attachment.

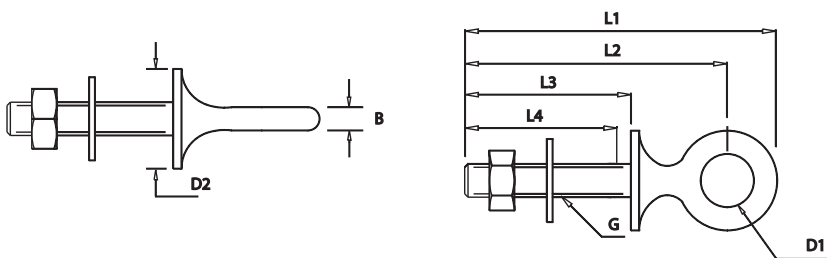

## EYE BOLTS FORGED

Polished stainless steel - AISI 316

ART. NO.	G	D1	D2	B	L1	L2	L3	L4	BL/KG	KG/100	PACK
310630	M6	6,5	25	4	53	46	30	30	1200	1,3	10
310660	M6	6,5	25	4	83	76	60	60	1200	2,1	10
310835	M8	8,5	25	5	65	58	35	35	2200	3,3	10
310880	M8	8,5	25	5	110	104	80	75	2200	5	10
311050	M10	10,5	30	6	87	75	50	50	3500	8,2	10
311000	M10	10,5	30	6	137	125	100	85	3500	11	10

Note: All break loads are determined by eye (D) and thread



The forged eye bolts are supplied with a pre-welded cover disc, washer and nut and offer a strong attachment.

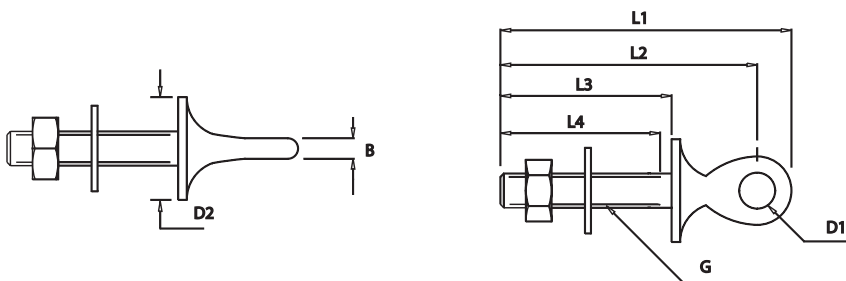

## SECURITY "U" BOLTS

Polished stainless steel - AISI 316 - Wst. 1.4401

ART. NO.	G	Ø	A	D	L1	L2	L3	L4	BL/KG	KG/100	PACK	BREAK NUT
<b>Class 3 certified</b>												
431265	M12	32	46	14	122	65	41	48	5100	31	1	50 Nm
<b>Class 2 certified</b>												
431045	M10	28	40	12	95	45	38	40	3500	22	1	50 Nm

Note: All break loads are determined by thread

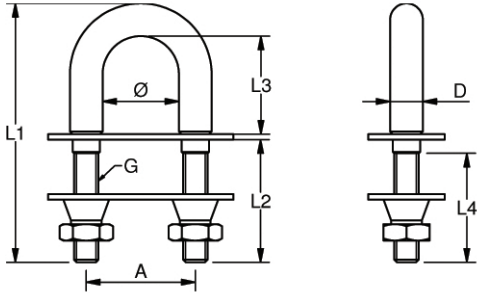

Swedish certified security and anti-theft U bolt.

The hardchromed surface makes cutting attempts extremely hard and the conical security lock nut can't be removed once mounted.



## "U" BOLTS

Polished stainless steel - AISI 316

ART. NO.	G	A	D	L1	L2	L3	L4	BL/KG	KG/100	PACK
340435	M4	30	4	66	35	25	30	750	2,1	25
340535	M5	30	4,4	67	35	25	30	900	2,6	25
340635	M6	33	5,3	67	35	26	30	1250	4,5	5
340650	M6	33	5,3	84	50	26	30	1250	5,7	5
340835	M8	33	7,1	71	35	26	30	1750	7,2	5
340850	M8	33	7,1	86	50	26	30	1750	9,7	5
340880	M8	33	7,1	116	80	26	45	1750	11,8	5
348840	M8	50	8	80	40	30	32	1750	12,4	5
348850	M8	50	8	90	50	30	32	1750	13,2	5
341045	M10	40	10	95	45	40	40	3500	18,4	5
341060	M10	40	10	110	60	40	35	3500	20,4	5
341010	M10	40	10	150	100	40	85	3500	25	5
341280	M12	47	10,8	122	80	30	85	5100	29	5

Note: All break loads are determined by thread. Use of thread lubricite is recommended.

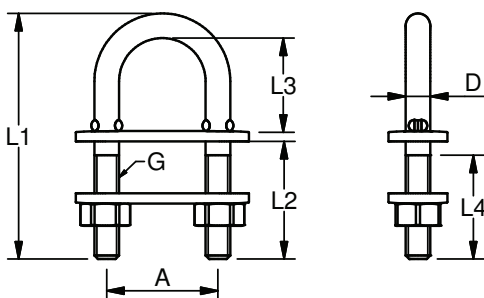

## EYE STRAPS

Polished stainless steel - AISI 316

ART. NO.	H	A1	A2	D1	D2	KG/100	PACK
150401	12	28	11	4,2	9	0,3	100
155102	13	34	15	5,2	11	0,5	100
155203	19	44	20	5,2	12	1	100
155304	24	64	28	5,2	10	1,2	50
156205	29	69	32	6,4	14	2	50

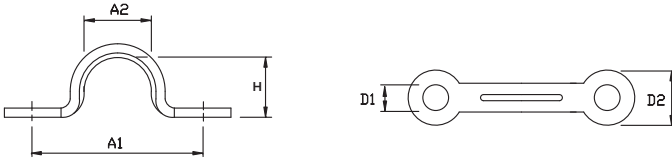

Eye straps are used for various attachments and fixing points . Place it over two pre-drilled holes and if possible use a pop rivet for easy attachment .

## STRAP - EYE

Polished stainless steel - AISI 316

ART. NO.	D1	D2	D3	L1	L2	L3	BL/KG	KG/100	PACK
150404	4,2	9	7	15	4,7	1,5	500	0,3	100
150505	5	11	10	24	7,3	2	1000	0,8	100

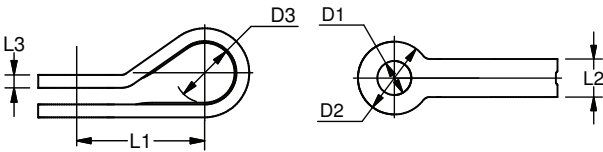

The Strap eye is the one hole version of the eye strap. Used with a pop rivet e.g. for cabling.

The flat shackles have been produced by Blue Wave for more than half a century. A high quality product stamped from AISI 316L plate material with high break loads. Available in various models versions and flexible in use with the remaining range of products or as attachment to an existing construction.

## SHACKLES

Polished stainless steel - AISI 316

ART. NO.	A	D	L	BL/KG	KG/100	PACK
160041	10	M4	15	500	0,5	100
160051	12	M5	17	1000	1	100
160052	16	M5	24	1000	1,6	100
160053	16	M5	36	1100	1,8	100
165251	13,5	M5	25	1100	1,5	100
165206	16	M6	23	1400	1,6	50

Note: All break loads are determined by pin and thread

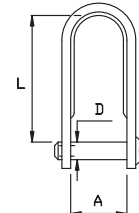

## SHACKLES

Polished stainless steel - AISI 316

ART. NO.	A	D	L	BL/KG	KG/100	PACK
150041	10	M4	15	500	0,5	100
150051	12	M5	17	1000	1,6	100
150052	16	M5	24	1000	1,6	100
150053	16	M5	36	1100	1,8	100
155251	13,5	M5	25	1100	1,5	100
155206	16	M6	23	1400	1,6	50
150062	14	M6	40	2000	2,9	50
150082	18	M8	42	3000	5	50

Note: All break loads are determined by pin and thread

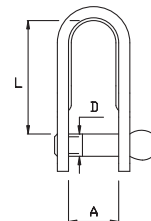

## SHACKLES

Polished stainless steel - AISI 316

ART. NO.	A	D	L	BL/KG	KG/100	PACK
150061	14	M6	23	2000	2,5	50
150081	17	M8	31	3000	4,5	50
150010	21	M10	40	4800	8,5	25
150012	25	M12	50	7000	16	25

Note: All break loads are determined by pin and thread

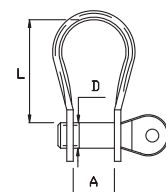

## SHACKLES

Polished stainless steel - AISI 316

ART. NO.	A	D	L	BL/KG	KG/100	PACK
151010	21	M10	40	4800	9	25
151212	25	M12	50	7000	16,5	25

Note: All break loads are determined by pin and thread

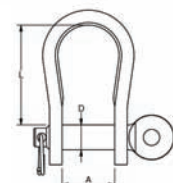

## THIMBLES WELDED

Polished stainless steel - AISI 316

ART. NO.	Ø	A	A1	B	L	S	KG/100	PACK
119908	6	9	13,5	22	22	2	2,9	25
119909	6	10	13,75	24	24	2	3,2	25
119910	8	11	15,3	27	27	3	5,9	25
119912	8	14	18,3	29	29	3	6,3	25
119914	10	16	21	32	32	3	12,3	10
119916	10	18	23	40	40	3	13,6	10
119918	12	20	26,5	45	45	4	24	10
119920	12	22	30,5	50	50	4	34,8	10
119922	16	24	32	56	56	5	51,8	BULK
119926	16	28	37,5	60	60	6	85,6	BULK



The reinforced thimble is based on the standard thimble but extra force is attained by the addition of a welded bar, as well as the ends of the thimbles being welded together.

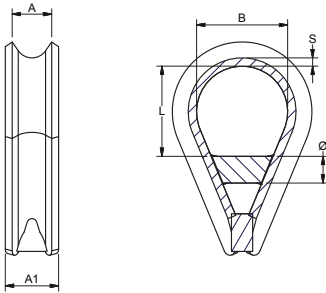

## THIMBLES

Polished stainless steel - AISI 316

ART. NO.	A	A1	B	L	S	KG/100	PACK
110002	3	5,25	9	16	1	0,2	100,0
110003	4	6,25	10	17	1	0,3	100,0
110004	5	7,5	11	19	1,35	0,5	100,0
110005	6	8,5	13	21	1,2	0,7	100,0
110006	7	9,7	15	27	1,5	1,1	100,0
110007	8	11	19	33	1,5	1,4	100,0
110008	9	13,5	22	38	2	2,6	50,0
110009	10	13,75	24	43	2	3,1	50,0
110010	11	15,3	27	46	2,7	4,9	BULK
110012	14	18,3	29	52	2,7	6,6	BULK
110014	16	21	33	57	3	9	BULK
110016	18	23	40	67	3	11,3	BULK
110018	20	26,5	45	75	4	19	BULK
110020	22	30,5	52	84	4	31,2	BULK
110022	24	32	56	93	5	45,5	BULK
110026	28	37,5	65	112	6	67	BULK
110028	30	40	80	135	5,5	82	BULK
110032	34	43	92	160	6,25	110	BULK
110034	36	46,5	105	160	6	117	BULK
110036	38	49	115	176	6	142	BULK
110038	40	53,5	120	180	8	206	BULK
110040	42	55	120	192	8	220	BULK
110042	45	56,5	150	240	8	304	BULK



The thimbles from Blue Wave are known worldwide for supreme quality and are often the first choice for the harsh environment of the marine sector.

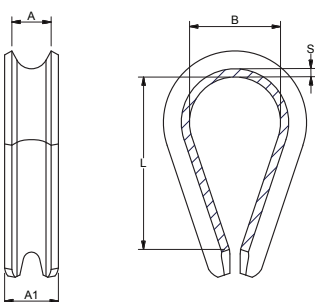

A -

## LOCK NUT

Polished stainless steel - AISI 316

NO. RIGHT	NO. LEFT	G	H	KW	KG/100	PACK
041205	051205	M5	4	8	0,1	BULK
041206	051206	M6	4	8	0.10	BULK
041208	051208	M8	5	10	0,15	BULK
041210	051210	M10	6,5	13	0,25	BULK
041212	051212	M12	8	17	0,7	BULK
041214	051214	M14	9,5	19	1,3	BULK
041216	051216	M16	11	22	2	BULK
041220	051220	M20	13	24	2,25	BULK
041222	051222	M22	16,5	30	3,5	BULK
041224	051224	M24	17,5	36	8,8	BULK
041227	051227	M27	22	41	16	BULK
041230	051230	M30	24	46	17	BULK
041236	051236	M36	29	55	39	BULK
041248	051248	M48	38	70	79,9	BULK
041252	051252	M52	42	75	98,8	BULK
041256	051256	M56	45	85	143,7	BULK



Nuts may be used for locking e.g. a rigging screw or they are very useful to tighten a thread terminal to tension a wire.

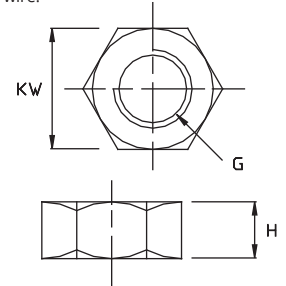

## TOP NUT

Polished stainless steel - AISI 314

ART.NO.	G	KW	KG/100
A040503	M5	8	0,2
A040604	M6	10	0,4
A040806	M8	13	0,9

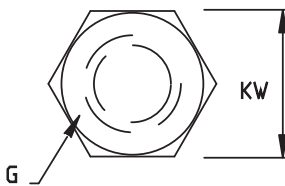

The top nut locks and at the same time covers up the thread end.

## SECURITY NUT

Polished stainless steel - AISI 316

ART. NO.	G	D	L	KW	KG/100	BREAK	PACK
044310	M10	17	9	17	1,3	50Nm	BULK
044312	M12	20	10,5	22	2,3	50Nm	BULK

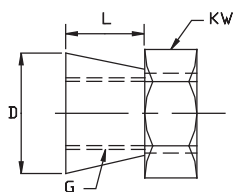

The security nut is the ideal solution where the nut has to remain permanently tightened. Once tightened, the KEY part breaks off and only a cone is left.

## CLEVIS PIN

Polished stainless steel - AISI 316

ART. NO.	D	L	KG/100	PACK
061304	4	13	0,2	BULK
060805	5	8	0,2	BULK
061605	5	15	0,3	BULK
061806	6	17	0,9	BULK
061663	6,35	16	0,9	BULK
061908	8	18	1	BULK
062008	8	21	1,1	BULK
062395	9,5	23	1,5	BULK
061910	10	19	1,7	BULK
062611	11	26	2,4	BULK
062812	12	28	3	BULK
063012	12	30	3,5	BULK
063412	12	34	4	BULK
063214	14	32	5,3	BULK
063714	14	37	5,5	BULK
063416	16	34	6,5	BULK
064016	16	40	7,7	BULK
064419	19	44	13	BULK
064919	19	49	14	BULK
064622	22	46	16,3	BULK
065522	22	55	19	BULK
065822	22	58	20	BULK
065525	25,4	55	25	BULK
066325	25,4	63	28	BULK
067328	28	73	40	BULK
068332	32	83	60	BULK
068835	35	88,5	76	BULK

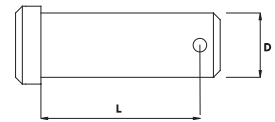

Pins and G-rings are spare parts for the WDS program.

## PRESS-PINS

Polished stainless steel - AISI 316L

ART. NO.	D	L	KG/100
061505P	5	15	0,4
061706P	6	17	0,5
062008P	8	20	1
062210P	10	22	1,7

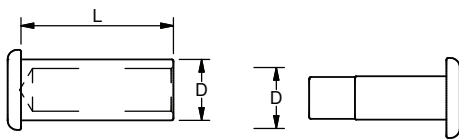

The press pin is a tamper proof alternative to the standard clevis pins. Fits the Blue Wave welded forks.

## DOUBLE HEADED PIN

Polished stainless steel - AISI 316

ART. NO.	D	L	KG/100
061606H	6	16,2	1
062008H	8	19,5	1,5
062110H	9,8	21,2	2,4

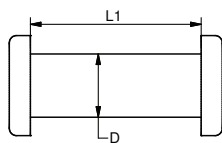

Elegant and tamper proof alternative to standard clevis pins. Fits the Blue Wave welded forks.



## SPLIT PINS

Stainless steel - AISI 316

ART. NO.	DIM	L	KG/100	PACK	Thread	Split hole
					Size	Ø
070609	1,5	10	0,01	100	-	-
0706101	2	12	0,03	100	1/4"	2,2
070610	2	15	0,03	100	1/4"	2,2
070611	2	25	0,05	100	1/4"	2,2
0706121	2,5	16	0,06	100	5/16" + 3/8"	2,8
070612	2,5	25	0,1	100	5/16" + 3/8"	2,8
0706131	3,2	20	0,14	50	7/16" + 1/2"	3,5
070613	3	25	0,15	50	7/16" + 1/2"	3,5
070614	3	32	0,2	50	7/16" + 1/2"	3,5
0706151	4	32	0,35	BULK	5/8" + 3/4"	4,5
070617	5	40	0,75	BULK	7/8" + 1"	5,5
070618	6,3	50	1,3	BULK	-	-



## G-RING

Stainless steel - AISI 316

ART.NO.	DIM.	D	KG/100	PACK
070601	1	11	0,015	100
070602	1,25	15	0,075	100
070603	1,5	19	0,1	100
070604	2	23	0,23	100

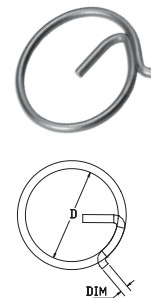

## STAINLESS STEEL WIRE ROPE

Stainless steel - AISI 316

Blue Wave delivers wire rope in following standard reel sizes

Please order:      Example:  
**125** Meter: Cat. No. +/1      WR119021  
**250** Meter: Cat. No. +/2      WR119022  
**500** Meter: Cat. No. +/3      WR119023

### 1 x 19 AISI 316 - DIN 3053

ART. NO.	DIM. MM	TENSILE STRENGTH KG	CA. KG/100
WR11902	2	336	1,99
WR11925	2,5	525	3,1
WR11903	3	756	4,47
WR11904	4	1346	7,95
WR11905	5	2100	12,4
WR11906	6	3027	17,9
WR11907	7	4119	24,3
WR11908	8	5302	31,8
WR11910	10	8035	49,7

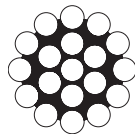
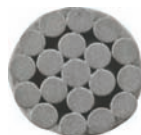

stiff wire construction

### 7 x 19 AISI 316 - DIN 3060

ART. NO.	DIM. MM	TENSILE STRENGTH KG	CA. KG/100
WR71902	2	212	1,58
WR71925	2,5	332	2,4
WR71903	3	478	3,84
WR71904	4	850	6,49
WR71905	5	1325	9,14
WR71906	6	1913	13,8
WR71908	8	3395	23,87
WR71910	10	5312	40,3

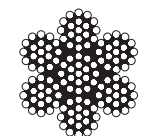

very flexible wire construction

### 7 x 7 AISI 316 - DIN 3055

ART. NO.	DIM. MM	TENSILE STRENGTH KG	CA. KG/100
WR70702	2	229	1,71
WR70725	2,5	369	2,6
WR70703	3	517	3,85
WR70704	4	918	7
WR70705	5	1435	10,5
WR70706	6	2068	14,8
WR70708	8	3676	25,5
WR70710	10	5741	38,8
WR70712	12	8269	55,5



flexible wire construction

### 1 x 19 AISI 316 COATED WHITE

ART. NO.	DIM. MM	TENSILE STRENGTH KG	CA. KG/100
CW119460	4 - 6	1346	9,5



stiff wire construction

### 7 x 7 AISI 316 COATED WHITE

ART. NO.	DIM. MM	TENSILE STRENGTH KG	CA. KG/100
CW707460	4 - 6	918	8,75



flexible wire construction

## WDS CRIMPING TOOL

WDS Accu Tool for 3-6 mm SMALL WDS terminals

ART. NO.	WIRE SIZE METRIC	CRIMPING DIAMETER	KG/1
ARCTOOL1ACC	3 - 6 MM	5,5 - 9 MM	3,2

Dies included

Note: Lose dies available on request

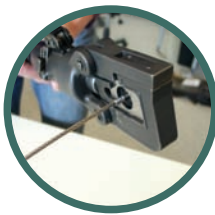

One-hand-operated Arctool, delivered in toolbox with a 18V 2200 mAh battery. Charges up to 1000 times. Each charge delivers power to press up to app. 100 times. For use and access in narrow places the head is turnable 180°. The pressing force is 55 kN and a "click" will be heard when pressing done. The tool is CE-certified.

## DUAL THREAD SCREW TONG

WDS Tool for dualscrew

ART. NO.	THREAD SIZE METRIC	KG/1
ARCTOOL3	M5 - M10	0,5

Right handed thread only.

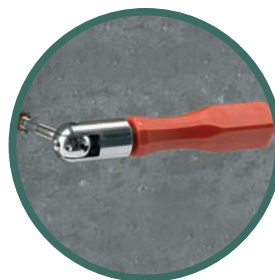
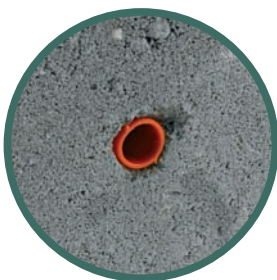

## CRIMPING TOOL

Economy Tool for 3-8 mm SMALL WDS terminals

ART. NO.	WIRE SIZE METRIC	CRIMPING DIAMETER	KG/1
ARCTOOL8	3 - 8 mm	5,5 - 12,6 MM	5,2

Note: Dies included

Note: Lose dies available on request

WDS tool for handcrimping SMALL WDS terminals Ø 3 mm - Ø 8 mm. Hydraulic and including dies.



## WDS CRIMPING TOOL

WDS Tong for 3 & 4 mm WDS SMALL fittings

ART. NO.	WIRE SIZE METRIC	CRIMPING DIAMETER	KG/1
ARCTOOL4	3 + 4 MM	5,5 - 6,35 MM	1,7

For use on flexible wire only. (eg. 7x19 & 7x7)



Mechanical WDS tong for crimping 3 and 4 mm SMALL fittings on flexible wire 7x7 and 7x19 construction.

## WIRE CUTTER

WDS Wirecutters up to 12mm

ART. NO.	WIRE SIZE	KG/1
ARCTOOL5	Max dia 4 / 5/32"	0,7
ARCTOOL6	Max dia 7 / 9/32"	1,5
ARCTOOL7	Max dia 12 / 1/2"	2,8



[www.bluewave.dk](http://www.bluewave.dk)

Blue Wave reserves the right to change specifications and descriptions contained in the WDS catalogue with no notification. 2022 - 1. edition.